



IEA
SOLAR R&D

INTERNATIONAL ENERGY AGENCY

program
to develop and test
solar heating
and cooling systems

task III
performance testing
of solar collectors

subtask b
Development of test procedures for
reliability and durability

**FAILURE MODES
OF SOLAR COLLECTORS**

august 1981

IEA TASK III

report on subtask b

Development of Reliability and Durability Test Procedures
for Solar Collectors

FAILURE MODES OF SOLAR COLLECTORS

by

Peder Vejsig Pedersen

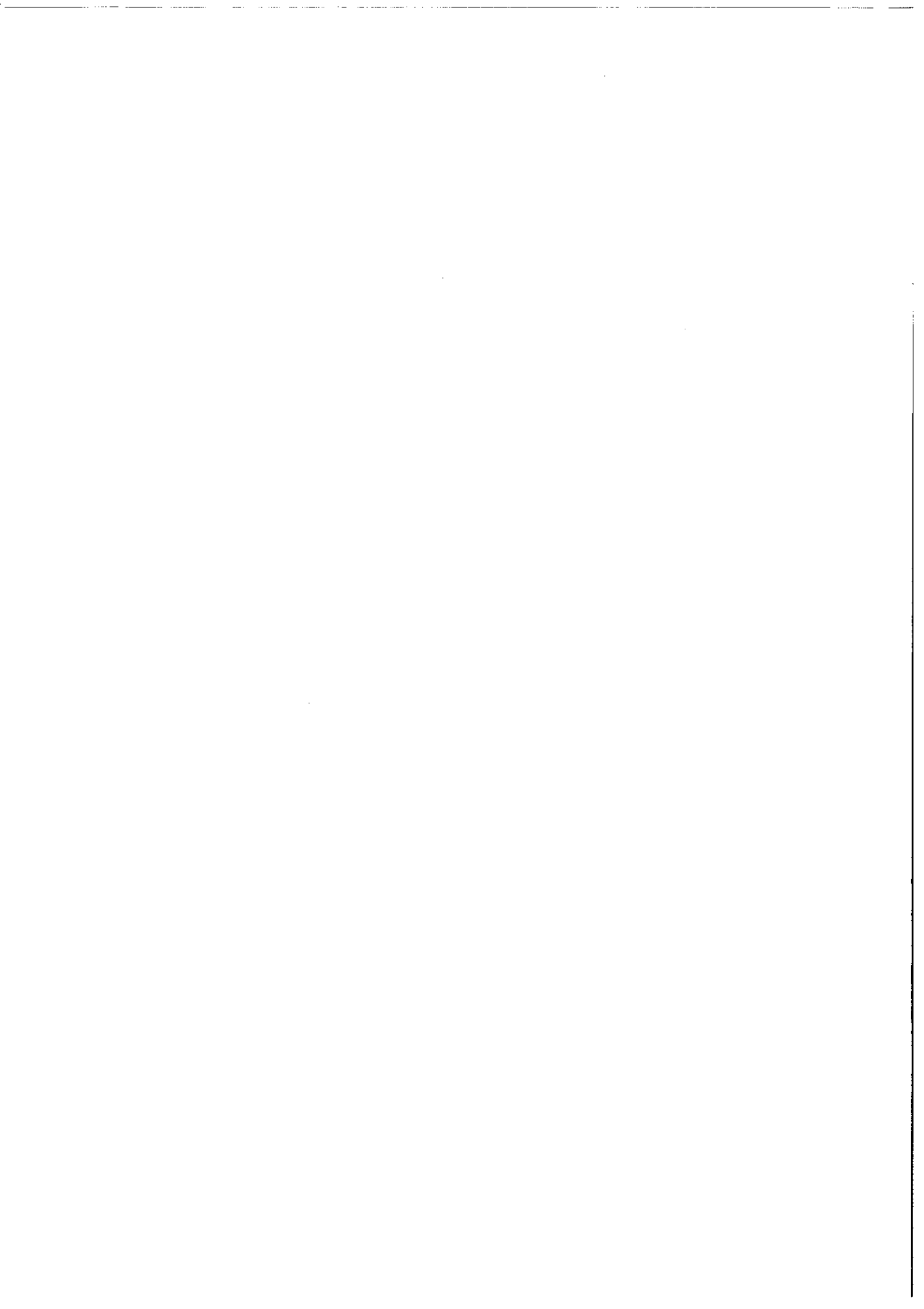

PREFACE

INTERNATIONAL ENERGY AGENCY

In order to strengthen cooperation in the vital area of energy policy, an Agreement on an International Energy Program was formulated among a number of industrialized countries in November 1974. The International Energy Agency (IEA) was established as an autonomous body within the Organization for Economic Cooperation and Development (OECD) to administer that agreement. Twenty countries are currently members of the IEA, with the Commission of the European Communities participating under a special agreement.

As one element of the International Energy Program, the Participants undertake cooperative activities in energy research, development, and demonstration. A number of new and improved energy technologies which have potential for making significant contributions to our energy needs were identified for collaborative efforts. The IEA Committee on Energy Research and Development (CRD), assisted by a small Secretariat, coordinates the energy research, development, and demonstrations program.

SOLAR HEATING AND COOLING PROGRAM

Solar Heating and Cooling was one of the technologies selected by the IEA for a collaborative effort. The objective was to undertake cooperative research, development, demonstrations and exchanges of information in order to advance the activities of all Participants in the field of solar heating and cooling systems. Several tasks were developed in key areas of solar heating and cooling. A formal Implementing Agreement for this Program, covering the contributions, obligations and rights of the Participants, as well as the scope of each task was prepared and signed by 15 countries and the Commission of the European Communities. The overall program is managed by an Executive Committee, while the management of the subprojects is the responsibility of Operating Agents who act on behalf of the other Participants.

The tasks of the IEA Solar Heating and Cooling Program and their respective Operating Agents are:

- I. Investigation of the Performance of Solar Heating and Cooling Systems -
Technical University of Denmark.
- II. Coordination of R&D on Solar Heating and Cooling Components -
Agency of Industrial Science and Technology, Japan
- III. Performance Testing of Solar Collectors -
Kernforschungsanlage Jûlich, Federal Republic of Germany
- IV. Development of an Insulation Handbook and Instrumentation Package -
United States Department of Energy (finished)
- V. Use of Existing Meteorological Information for Solar Energy Application -
Swedish Meteorological and Hydrological Institute
- VI. Performance of Solar Heating, Cooling and Hot Water Systems Using Evacuated Collectors -
United States Department of Energy
- VII. Central Solar Heating with Seasonal Storage -
Swedish Council for Building Research

Collaboration in additional areas is likely to be considered as projects are completed or fruitful topics for cooperation identified. At the moment a new task, "Passive and Hybrid Low Energy Buildings", is under consideration for initiation.

TASK III - PERFORMANCE TESTING OF SOLAR COLLECTORS

A wide variety of collector designs with a broad range of qualitative differences exists. Since the collector is the key component in an active solar system, performance testing is a vital task. The objective of Task III is to develop internationally accepted test procedures for determining the thermal performance as well as the reliability and durability of collectors. This project is also experimenting with the use of solar simulators to allow year-round testing of collectors.

The subtasks of this project are:

- A. Development and Application of Standard Test Procedures for Determining Thermal Performance
- B. Development of Reliability and Durability Test Procedures
- C. Investigation of the Potential of Solar Simulators

The following countries are Participants in Task III:

Austria, Belgium, Canada, Denmark, Federal Republic of Germany, Greece, Italy, Japan, The Netherlands, New Zealand, Spain, Sweden, Switzerland, United Kingdom, U.S.A., and the Commission of the European Communities.

This report documents work carried out under subtask B of Task III.

Table of contents

Summary 5

Introduction 7

Chapter 1
Inspection of Solar Collectors - The Objective 9

Chapter 2
Durability and Reliability of Solar Collectors -
Problems observed in practice 10

Chapter 3
Evaluation of observed problems, failures and changes ... 21
3.1 Procedure for and results of the evaluation 21
3.2 The inspected solar collectors 24
3.3 Development of a new inspection format and
objectives for a new inspection round 38

Reference list 39

Appendix A
Inspection reports of solar collectors in solar energy systems.

Appendix B
Investigation of common problems, failures and changes for the collectors.

Appendix C
The new IEA Task III inspection format.

Appendix D
Examples of recommendations for solar collector construction.

Appendix E
List of contact Persons and Responsible Researchers.

SUMMARY

In appendix A of this report you will find a compilation of solar collector inspection reports from the Participants of IEA, Task III. There are contributions from United Kingdom, Sweden, New Zealand, Denmark, U.S.A., Germany, Holland, Austria and Japan. In all there are 25 inspection reports, and no country is represented with more than 4 reports. With U.S.A. and New Zealand as exceptions, all inspections are made in more or less rainy climates, and with frost and snow during the winter. The influence on solar collector reliability and durability from this kind of climate is, of course, very different from the influence you will find in, for example, New Mexico in U.S.A. Therefore the demands to construction methods and materials used for solar collectors are very much dependent on the climate they will be exposed to in operation.

It is important to stress that the results of the inspections presented in this report do not give any precise picture of the reliability and durability of solar collectors in the IEA-participating countries. The number of inspected collectors is too small for that, and it is probable that many collectors have been chosen for inspection because they were known to have experienced problems. The aim was to inspect collectors in operation in order to get information and to investigate typical failure modes of solar collectors.

In chapter 1 there is a short discussion of the inspection reports.

Chapter 2 is a catalogue of observed problems, changes and failures of the inspected solar collectors. A division is made with respect to:

1. The different parts of the collector.
2. Problem areas of the collector with respect to construction, materials used, production and installation.

3. The influences from climate and surroundings on the collector.

In chapter 3 the inspected collectors are listed together with an indication of observed problems. This chapter also includes a short evaluation of the most common problems, and comments on a new inspection format which has been developed on the basis of recent experience with system inspections. The new inspection format is enclosed as appendix C.

An important task with respect to obtaining more durable and reliable solar collectors is to develop recommendations for collector construction in different climates. In appendix D are two examples showing how this is done in Denmark.

INTRODUCTION

A working programme to develop reliability and durability test procedures for solar collectors has been initiated. At present the programme has three different parts:

1. Information on reliability and durability of solar collectors in solar energy systems.
2. Assessment and modification of available standards for testing materials used in solar collectors.
3. Assessment and modification of procedures for testing the reliability and durability of complete solar collectors.

For part 1 it was decided that the first objective should be a collection of inspection reports on reliability and durability of solar collectors in operation in the participating countries.

An inspection format for this purpose was developed and later revised at the IEA-Task III meeting in Borås, June 1980.

Here it was also decided that the Participants should use the format and report the reliability and durability of solar collectors in at least three different solar energy systems in each country. Reports on the inspected collectors were compiled and evaluated by the Danish Participant, and were presented in a first draft of this report at the Task III experts meeting in Vienna, February 1981.

1. INSPECTION OF SOLAR COLLECTORS - THE OBJECTIVE

The most important part of the inspection reports in appendix A is the description of the inspected solar collectors and the listing and discussion of the problems, changes and failures observed. Most of the Participants have not made many remarks on observed collector problems. Of course, this item is not very important if you want to make only a statistical evaluation on which kind of collector problems are the most common. But if you want also to analyse the problems more deeply, it is important that all observed problems are discussed and that ways to get rid of them or ways to repair failures are evaluated.

If you also want to make practical use of the reported experience on durability and reliability of the inspected solar collector, for example, to make recommendations for collector construction, then a very detailed description of the inspected collectors is essential, and pictures and figures as documentation are necessary.

Inspection of solar collectors in operation is a part of the agreed upon working programme within the IEA, Task III, sub-task b. The goal of the programme is to develop procedures for testing the reliability and durability of solar collectors. Here it is necessary to know the problems, failures and changes that occur with solar collectors in practical operation, and to compare the results of the different test procedures with this experience. To obtain this goal a simple list of collector problems might be sufficient.

However, if you consider that a vital part of collector testing is to evaluate the collectors and give recommendations for a better collector construction, for example to help the manufacturers in improving them, then you have to go deeper into the observed collector problems. A simple list will not be enough.

2. DURABILITY AND RELIABILITY OF SOLAR COLLECTORS - PROBLEMS OBSERVED IN PRACTICE

In this chapter we will present a list of solar collector problems, failures or changes which have been observed in existing solar heating systems. Most of the problems mentioned are taken from the inspection reports in appendix A, others are mentioned in (1), (4), (6) and (7).

It is suitable to refer the problems, failures or changes in solar collectors to the different parts of the collector or the solar heating system in which it is working, that is:

1. cover
2. cover/enclosure assembly, gaskets and sealants
3. absorber
4. insulation in the sides and the back
5. enclosure
6. attachment, mounting of collector
7. flashing of the collector
8. connections and piping
9. the solar system
10. maintenance and repair of the collector

Problems or changes observed in solar collectors can always be related to the parameters of the solar collector, for example, the collector construction or the design of the solar system in which the collectors are working. The most common reasons for failures, problems or changes are the following:

1. the solar collector construction or design
2. the solar collector materials used
3. the production or treatment of the solar collector
4. the installation, assembly or piping of the solar collector
5. maintenance of the solar collector
6. the design or the operation of the solar heating system

The above mentioned characteristics of solar collectors will sometimes be the only reasons for problems, failures or changes, which sooner or later will be observed. But usually it will be a combination of these things together with the influence from the climate conditions that will have the most severe influence on solar collector reliability and durability.

The influence of the climate and the surroundings which the solar collectors are exposed to, can be divided into:

1. influence of stagnation and high temperatures
2. influence of introduction of moisture or water into the solar collector
3. influence of other climate parameters such as wind, insolation from the sun, ice, snow, dust, dirt and pollution
4. repair or maintenance of the collector

Often the combined influence, for example, from temperature and humidity is more severe than one of the above mentioned influences alone.

With the above mentioned in mind, a list of problems, failures and changes of solar collectors, observed at collector inspections, are made.

The notations used refer to "The different parts of the collector", "Category of problems, failures and changes" and "The influence on the collector of climate and surroundings". A survey of this is shown below.

Different parts of the collector and the solar system -----	The category of problems, failures and changes -----	Influence of surroundings and climate parameters -----
1 cover	1 collector construction	1 stagnation, high temperatures
2 cover/enclosure assembly, sea- lants, gaskets	2 collector materials used	2 moisture and water in the collector or piping
3 absorber	3 quality of production	3 other climate parameters, such as wind, sun and dirt
4 insulation	4 installation	4 repair and maintenance
5 enclosure	5 maintenance	5 the collector or the system alone
6 attachment and mounting of collector	6 operation	
7 flashing of collector	7 the climate alone	
8 connections and piping		
9 the solar system		
10 maintenance		
11 comments on efficiency		

If problems cannot be detected in reliability and short-time durability tests, then the symbol (L) will refer to this. L means long time effect. (S) could be used for a short-term effect, but here it will not be used.

PROBLEMS, FAILURES AND CHANGES OBSERVED FOR SOLAR COLLECTORS IN OPERATION

1. The cover

- 1.1.1 Broken cover. Often because of a temperature gradient in the cover resulting from cooling of the cover edge.

Collapsed cover. Often seen with plastic covers. These covers have a low heat transmission factor resulting in big differences between temperatures on the two sides of the cover and therefore differences in thermal expansion. The cover might touch parts of the absorber making it brown or destroying it.

Deposits from outgassing of materials are often seen on the inside of the cover. This might dissolve the cover material and reduce the transmission. Common outgassing products are from: insulation binder, sealant, paint, resin, rubber, gaskets (neoprene) and foam insulation.

- 1.1.2 Heavy condensation on the inside of the cover due to insufficient ventilation of the collector, or collector leakage resulting in a collector which is always, or very often, wet inside.

Climatic reasons for condensation include radiation from the cover to the sky, snow on the cover and rain.

- 1.1.3 Sealant might dissolve, resulting in a sticky cover which might collect a lot of dirt. (L).

- 1.2.3 Ageing of plastic covers, because of UV-insolation is often observed. (L).

- 1.2.3 It is difficult to avoid sagging of plastic foil covers.

- 1.3.3 The attachment of the cover to the collector enclosure is sometimes not durable. The cover might slip after some time. (L).

- 1.4.3 A problem often seen is that the collector is difficult to reach and repair after installation. Breakage of glass covers for a solar collector is always a significant risk, so unless a collector can be easily removed from its mounting and dismantled, this can lead to large expenses.
- 1.7.3 Dirt on collector covers is very common, especially in polluted areas, or if the collector is placed near a chimney. If a solar collector is situated near the sea, deposits of salt and sand on the cover can be very heavy and very often difficult to remove. (L).

2. Cover/enclosure assembly

- 2.1.1 Gaskets and sealant, used for the cover/enclosure assembly, sometimes work their way out because of thermal expansion. Either the cover or the enclosure may cause the cover to loosen.
- 2.1.2 An unsatisfactory cover/enclosure assembly, with respect to construction and material, might lead to breakage of the collector.

Shrinkage of rubber gaskets might lead to leakage in the corner of the cover/enclosure assembly.

- 2.1.3 Because of wind pressure and influence from temperatures the cover must be able to move horizontally and vertically. It is important that gaskets and sealants ensure that the cover does not loosen.
- 2.3.2 Silicone adhesive may be used to seal the cover/enclosure assembly. If degreasing is not done properly, leakage may occur.

3. The absorber

3.1.1 Warpage or bulging of the absorber can be the result of construction failures.

3.1.2 Proper functioning of the absorber over a long period of time is the most important aspect of solar collector durability. It is especially the combined effect of moisture in the collector and high temperatures which result in degradation of the absorber, sometimes also combined with polluted air. It is important to minimize these effects, for example by ensuring that it is impossible for water to enter or to be formed in the collector.

Condensation might drip onto the absorber surface leading to corrosion (usually in lines and spots). (L).

White-rust on the absorber surface is a severe problem which might change α and ϵ of the surface and lead to corrosion and leakage of the absorber. (L).

3.3.5 Some absorbers are leaking. Especially in the manifolds and connections this can be a problem.

Peeling of the absorber surface might occur if degreasing of the absorber material is not done properly before it is painted. (L).

3.4.5 If a wrong collector fluid is used, internal corrosion of the absorber might occur. (L).

3.6.3 Using drainage to protect against freezing is often not sufficient, because of failures in design. (L).

3.7.3 Dust and sand deposits on the absorber surface can be a problem. They can be introduced into the collector through ventilation holes or other places where the collector is not airtight. (L).

4. Insulation

- 4.1.1 Plastic foams used as insulation in solar collectors can fail at high temperatures. They may exhibit bulging, burning, brown discoloration and cracking.

The side insulation in solar collectors is often visible and discoloured. Sometimes it outgasses a deposit onto the glass cover.

- 4.1.2 Water in a solar collector is often absorbed in porous material such as insulation material. Once the water is there, it can be a problem to remove it.

- 4.3.1 If plastic foam is not made the proper way it is very sensitive to temperatures. It might degrade, or expansion might result in distortion of the enclosure.

- 4.3.5 Often the side insulation is not fastened sufficiently. After a period it might loosen. (L).

5. Enclosure

- 5.1.1 The primary objective of the solar collector enclosure is to protect the absorber against the climate.

- 5.1.2 Water being a result of rain, condensation or snow might be observed in the collector if the enclosure is not tight.

- 5.1.2 The enclosure might begin to corrode after a period if the surface treatment is not good enough.

The fillet at the bottom of the collector glass may gather water at the edge, or prevent snow from sliding off. This might lead to leakage even when a good silicone sealant has been used. An internal flashing in the collector might solve this problem. (L). Leakage is

often seen at the places where connections from the absorber pass through the enclosure.

Very often the enclosure is not protected against leakage at the corners.

When certain material combinations are used galvanic corrosion might occur. (L).

6. Attachment, mounting of collector

6.1.1 Collectors might loosen from attachments because of thermal expansion of the pipes, or influence from wind pressure. (L).

6.1.3 Formation of ice between collector and roof might lead to destruction of the collector.

6.4.2 When collectors are attached to a roof it is very important to avoid leaks in the roof.

6.4.5 Sometimes it is found that collectors are not mounted properly, the reason being that the instructions have not been followed as they should.

7. Flashing of the collector

7.1.2 The flashing of solar collectors built into the roof is difficult to make satisfactory. If leaking occurs water might enter into the house.

7.1.4 A simple construction or design of the flashing is very important when repair of the collector is necessary.

8. Connections and piping

- 8.1.1 When metal is used for the connections between collectors, thermal expansion of the piping system might destroy the collectors or the connections, leading to leakage. This type of connection needs a first class design but only very little maintenance and might have a long life time.
- 8.2.5 Collector connections are often made from flexible hoses of organic material. There are often problems with this type of connection with regard to leakage and airleakage into the piping system.
- 8.4.2 If the insulation of the piping system and connections is not protected it might get wet and destroyed, leading to corrosion.
- 8.4.5 Sometimes the insulation of the piping system from collector to storage is completely missing.
- 8.4.5 When copper pipes are used there are often problems with the soldering. Often the soldered joints are not cleaned well enough.
- 8.4.5 Often the flow distribution to solar collectors is not very good. A good flow distribution is best obtained when the drop of pressure in the collectors is above a certain level.

9. The solar system

- 9.6.5 If the collector area is over-dimensioned compared to the storage, boiling in the collector might occur, and the safety valve might let fluid out of the system. (L).

10. Maintenance and repair of the collector

10.1.5 When collector failures occur, repair of these failures is often very expensive. Often collectors are not designed for easy maintenance and repair. When a guarantee against failures is made it is important to insert a timelimit in the contract. (L).

11. Comments on efficiency

11.1.1 Condensation and deposits from outgassing might decrease the transmission.

Collapse of the cover will of course also increase the front heat loss.

11.1.5 Often the collector design is not very well optimized, for example:

- a high iron content in glass covers reduces transmission
- if the cover/enclosure assembly is not insulated, the cover edges are cooled.
- the thickness of side and back insulation is often not satisfactory.
- a too small cover/cover or cover/absorber spacing increases front losses.
- an uneven flow distribution between collectors influences their efficiency.
- if insulation of connections and the piping system is missing it has a considerable influence on efficiency.

11.2.1 If the insulation material is not durable at high temperatures, degrading, expansion, bulging, burning or cracking might occur. This has a considerable influence on efficiency.

11.2.2 Moisture or water in the insulation will also reduce efficiency.

Changes of α and ϵ of the absorber surface can decrease efficiency.

3. EVALUATION OF OBSERVED PROBLEMS, FAILURES AND CHANGES

3.1 Procedure for and the results of the evaluation

The solar collectors from the inspection reports in appendix A are evaluated by using the same method as used for the solar collector problems list. A code employing three numbers is used to indicate (a) the different part of the collector, (b) the category of observed problems, failures or changes, and (c) the influences from climate and surroundings which have been reported, (see fig.1).

<u>Different parts of the collector and the solar system</u>	<u>The category of problems, failures and changes</u>	<u>Influence of surroundings and climate parameters</u>
1 cover	1 collector construction	1 stagnation, high temperatures
2 cover/enclosure assembly, sealants, gaskets	2 collector materials used	2 moisture and water in the collector or piping
3 absorber	3 quality of production	3 other climate parameters, such as wind, sun and dirt
4 insulation	4 installation	4 repair and maintenance
5 enclosure	5 maintenance	5 the collector or the system alone
6 attachment and mounting of collector	6 operation	
7 flashing of collector	7 the climate alone	
8 connections and piping		
9 the solar system		
10 maintenance		
11 comments on efficiency		

Fig. 1 Problems, failures and changes of solar collectors are evaluated using a code containing three numbers.

(L) is used to indicate if observed problems, failures or changes are a result of a long term effect on the collector, so reliability and short-term collector tests could not be used to investigate this kind of problem.

The collectors are referred to by the letters A - Z:

	Collector
United Kingdom	A-B-C-Z
Sweden	D-E-F-G
Denmark	H-I-J-K
New Zealand	L-M-N
Holland	O-P-Q-R
United States	S
Germany	T1-T2-U
Austria	V-X-Y

In the following pages there are pictures of the collectors with problems indicated as explained. eg: 1-1-1 means that a failure or change has been observed on the cover and the reason for this is connected to the collector construction. Also that it was the influence of stagnation and high temperatures which was a part of the reason for the observed problem, failure or change. If a cover breaks at stagnation because of the construction of the collector, then it will be referred to as 1-1-1.

In appendix B are diagrams for 7 vital parts of the solar collector. Here is shown which collectors had the same combinations of design characteristics and influence from climate parameters and surroundings. Short comments on the different parts are also given.

COMMON PROBLEMS, FAILURES AND CHANGES IN THE INSPECTED SOLAR COLLECTORS ARE THE FOLLOWING:

1. Condensation, outgassing and dirt on covers
2. Breakage or collapse of covers
3. Ageing of plastic covers
4. Rain leakage into the solar collector because of cover/enclosure assembly leaking, or leaking through the enclosure, either at connection holes, corners or the lower glass fillet
5. Corrosion and white/rust on the absorber surface
6. Insufficient absorber surface treatment
7. Dirt and dust on absorber
8. Degradation and expansion of plastic foam insulation
9. Leaking of piping system or connections
10. Bad quality of work at collector installation, especially with insulation of piping system

3.2 The inspected solar collectors

The following pages show cross sections of the solar collectors from the inspection reports. Observed changes, failures or problems are indicated.

COLLECTOR CROSS SECTION

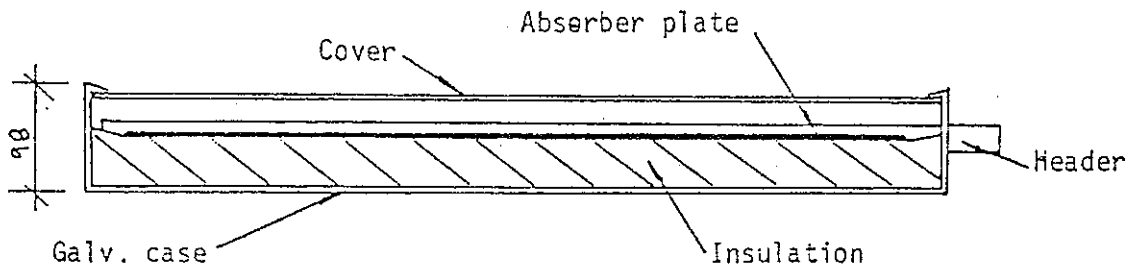

- Collector A: 1-1-2 Condensation
 1-2-1 Slight sag in cover
 1-7-3(L) Dirt on cover
 2-1-1(L) Seal damaged
 8-3-5 Pipework, insulation missing

COLLECTOR CROSS SECTION

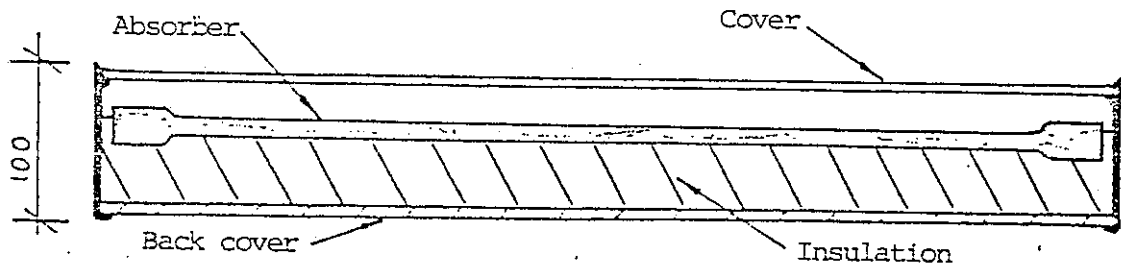

- Collector B: 5-1-2(L) Galvanic corrosion of enclosure
 5-1-2 Moisture in collector
 1-7-4 Glass breakage of one panel
 2-1-2 Cover glass seal not water tight
 3-2-2 Absorber corroded

CROSS SECTION THROUGH SOLAR COLLECTOR

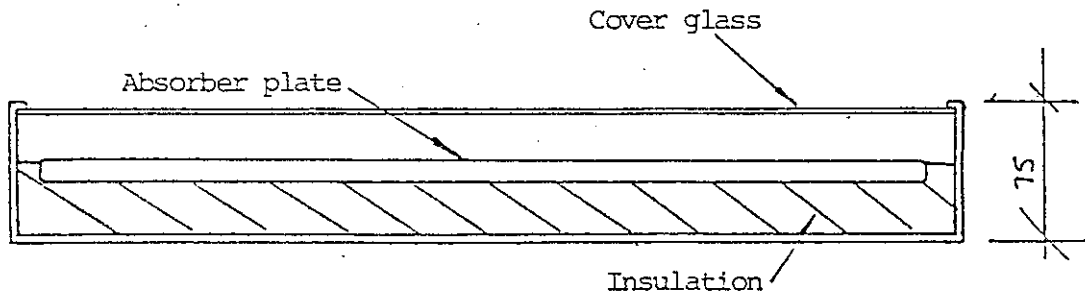

<u>Collector C:</u> 1-1-1	Glass breakage
3-2-2 (L)	Absorber coating discoloured
5-1-2 (L)	Steel supports and screws corroded
8-4-5 (L)	Connections of pipes degraded
8-4-2	Manifold insulation broken in places

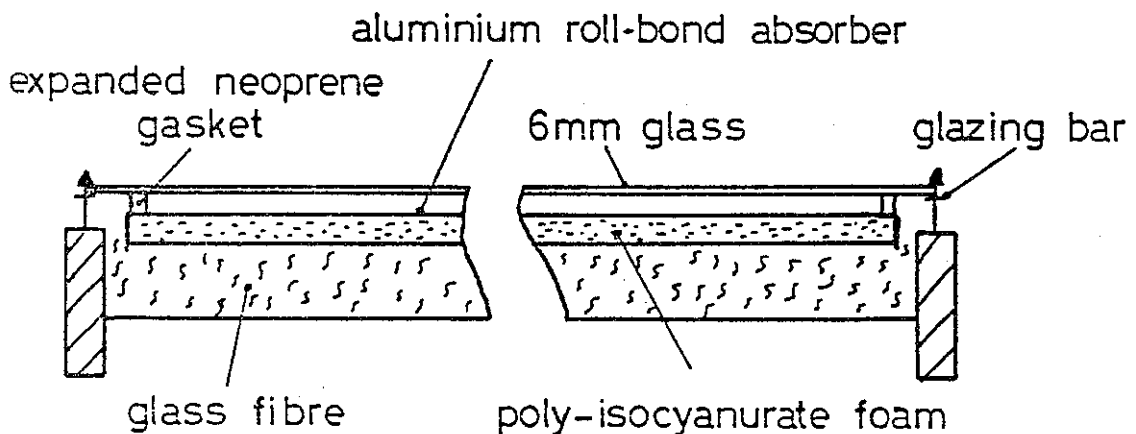

<u>Collector Z:</u> 1-1-2	Condensation
1-1-1	Glass cracked
1-7-3 (L)	Cover dirty
2-1-1 (L)	Neoprene gasket shrunk, sealant rope rotten
3-1-2 (L)	Absorber coating dirty and corroded
7-1-2 (L)	Flashing in poor condition

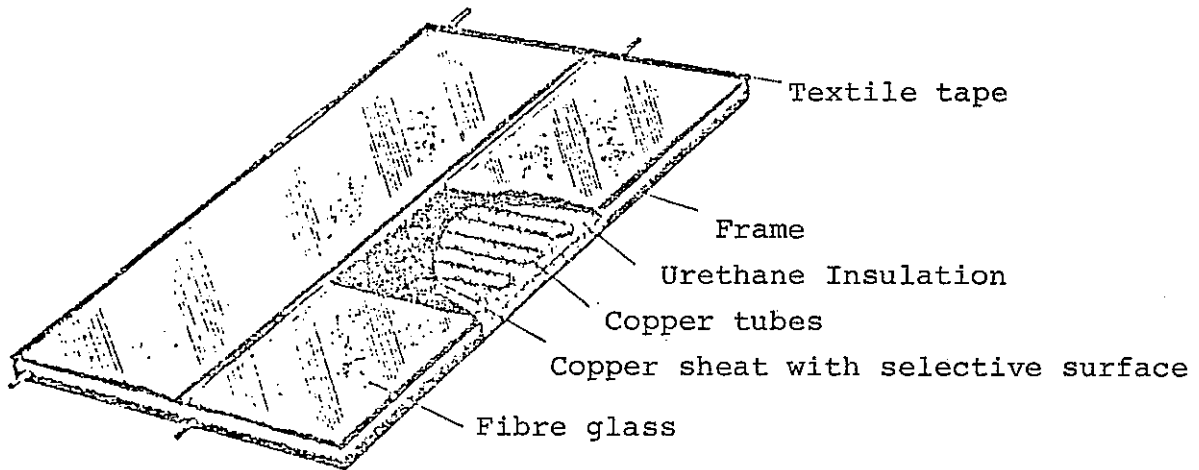

<u>Collector D:</u>	1-1-1	Yellow outgassing
	1-1-2	Condensation
	1-2-3 (L)	Cover ageing
	2-1-2 (L)	Textile tape destroyed
	3-1-3 (L)	Dust on absorber
	3-3-2 (L)	Corrosion at absorber edges

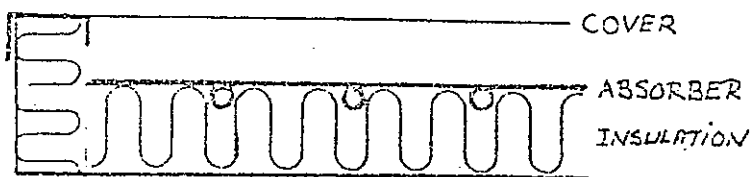

<u>Collector E:</u>	1-1-2	Condensation
	1-2-1	Cover bulging
	1-2-3 (L)	Ageing of cover
	1-3-5	Cover brown in places
	4-1-5	Visible insulation
	4-1-5	Side insulation loosened
	5-1-5	Cover support has loosened

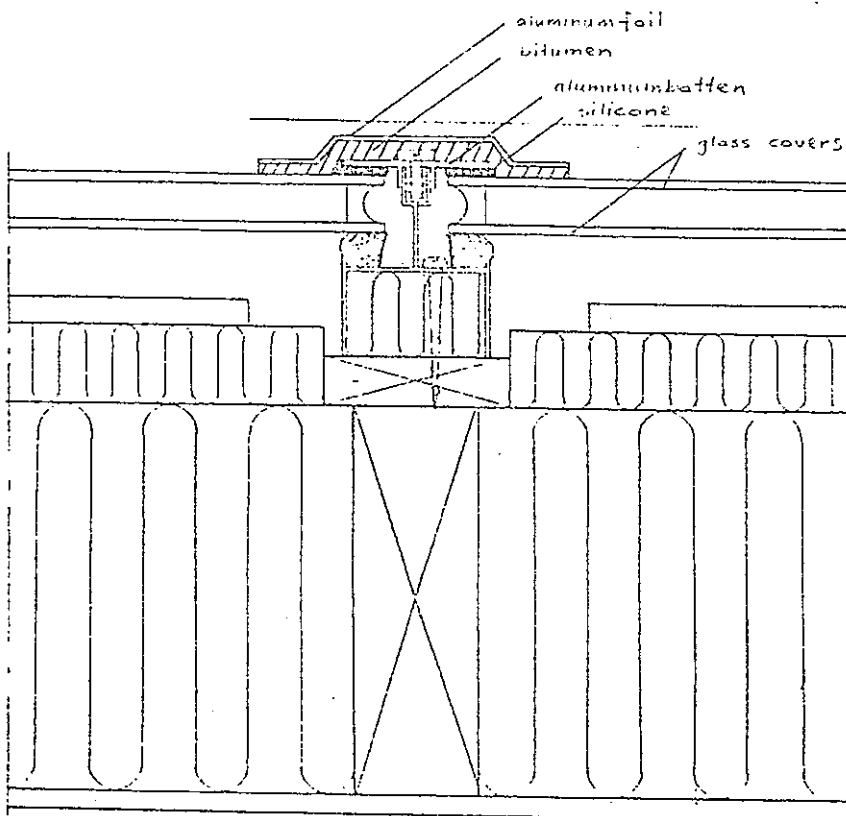

- Collector F: 1-7-3 (L) Dust on covers
 3-1-2 (L) Moisture in collector
 white rust on absorbers
 3-1-1 Absorbers bulged and
 almost touched cover

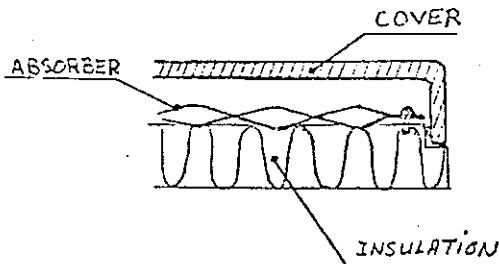

- Collector G: 3-1-2 (L) Absorber corroded in places
 3-3-5 Primer on absorber visible
 5-2-2 AL battens unstuck
 5-1-2 Traces of water on absorber

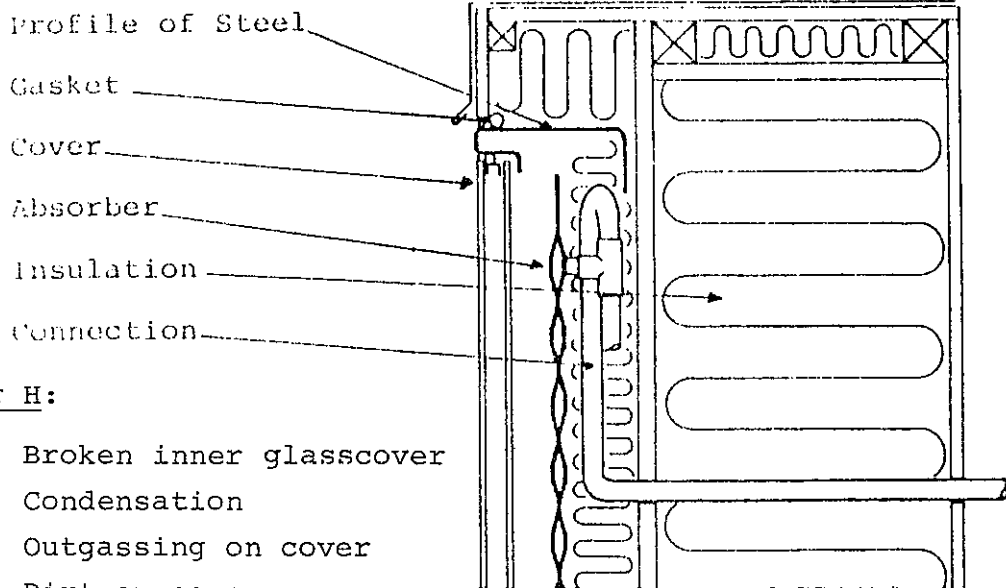

Collector H:

- 1-1-1 Broken inner glasscover
- 1-1-2 Condensation
- 1-2-1 Outgassing on cover
- 1-7-3 (L) Dirt on cover
- 8-3-2 (L) Corrosion of piping

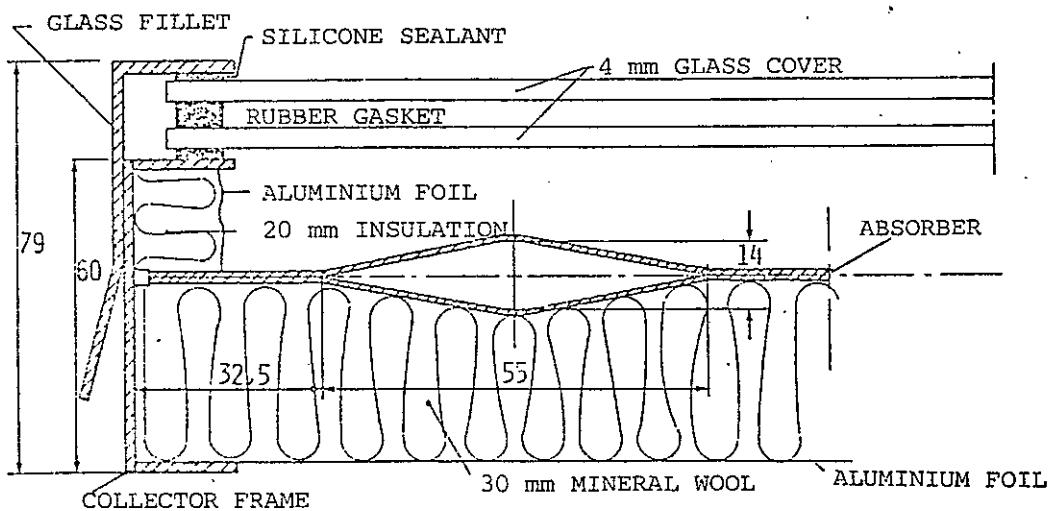
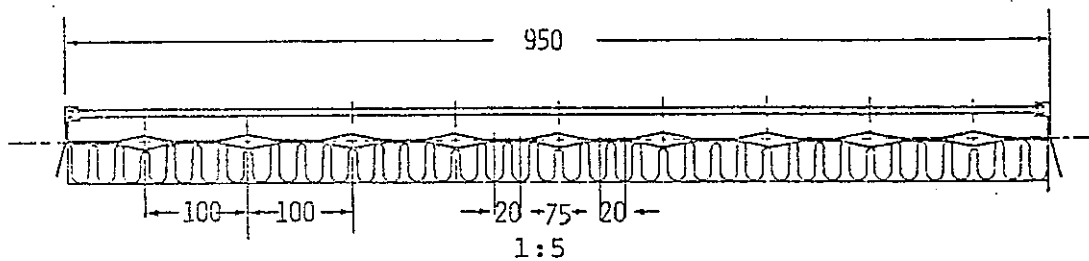

- Collector I:
- 1-1-2 Condensation
 - 1-7-3(L) Dirt on Covers
 - 2-2-3(L) Some silicone sealant dissolved.
 - 1-2-3 Cover spacing and insulation thickness too little
 - 5-1-2(L) Glassfillet causes rain leakage

Description of collector:
(see also fig. 2)

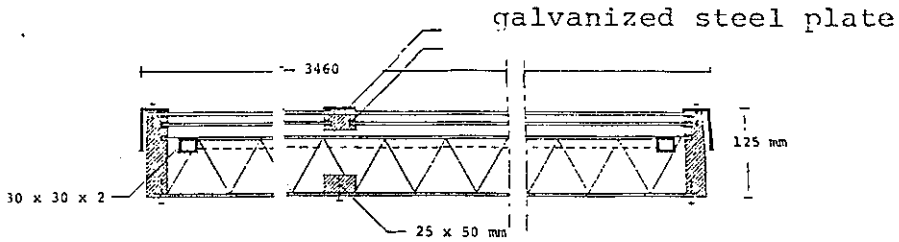
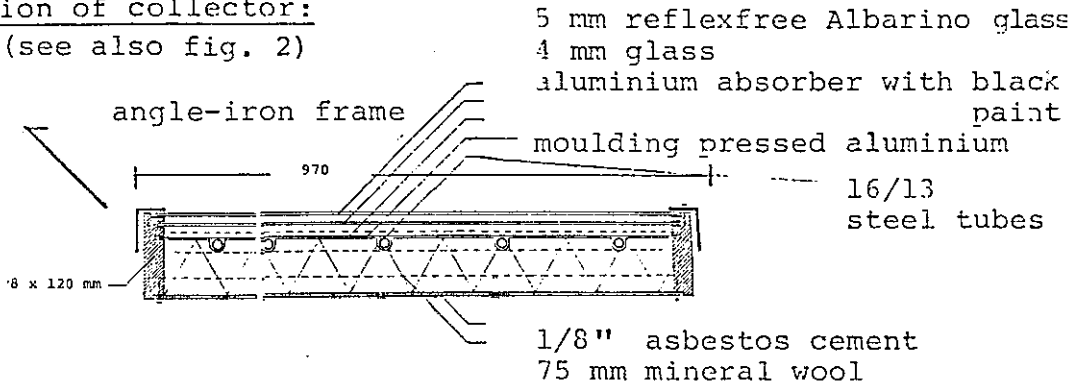

- Collector J: 1-7-3 (L) Dirt on covers
1-1-2 Condensation
1-2-1 (L) White deposit on covers
1-2-1 Outgassing on cover
3-2-1 Deposits on absorber
7-1-2 Flashing causes leakage
7-1-4 Repairing flashing is difficult

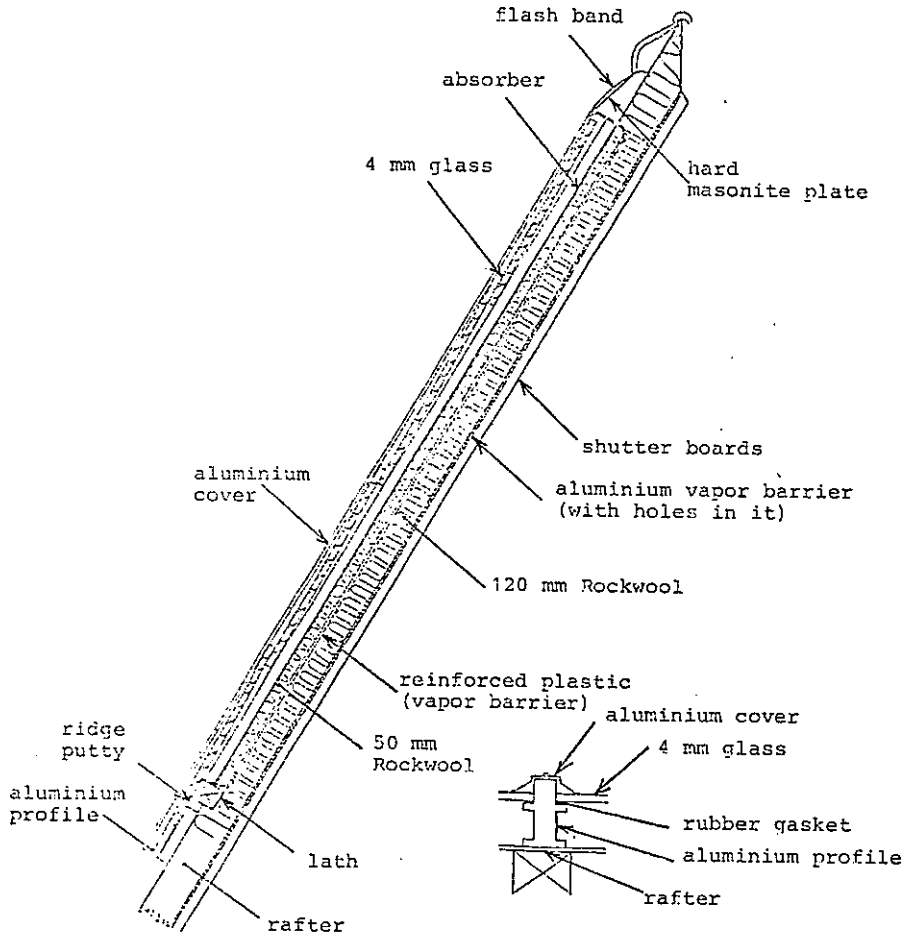
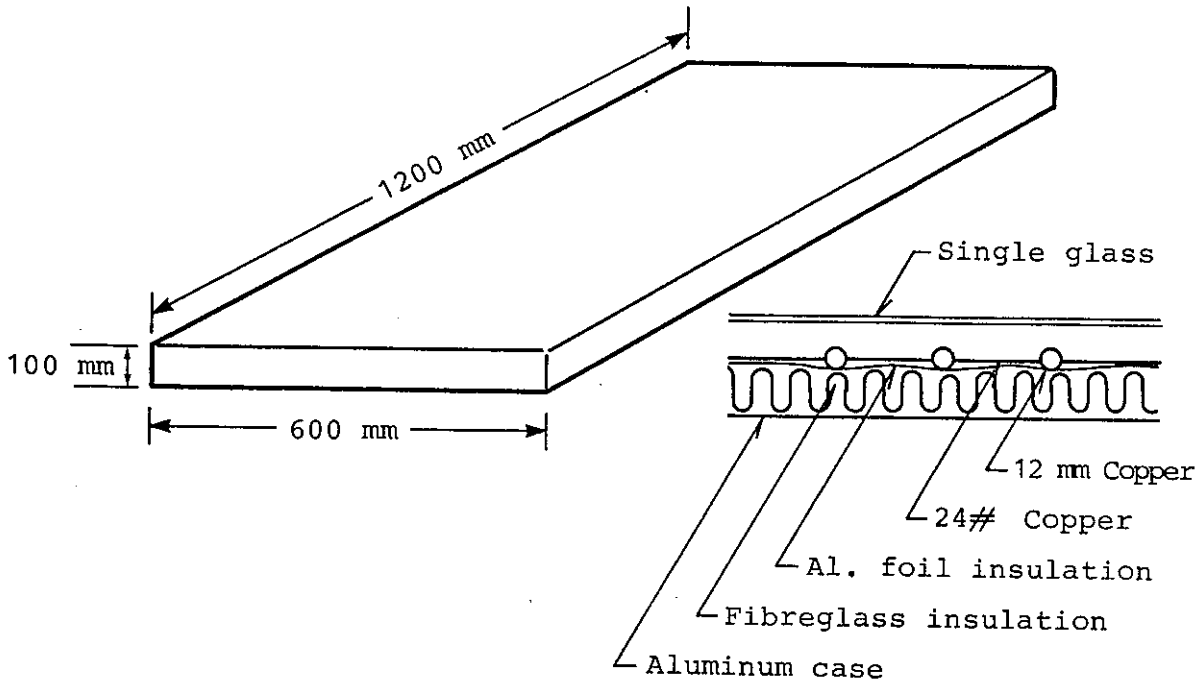
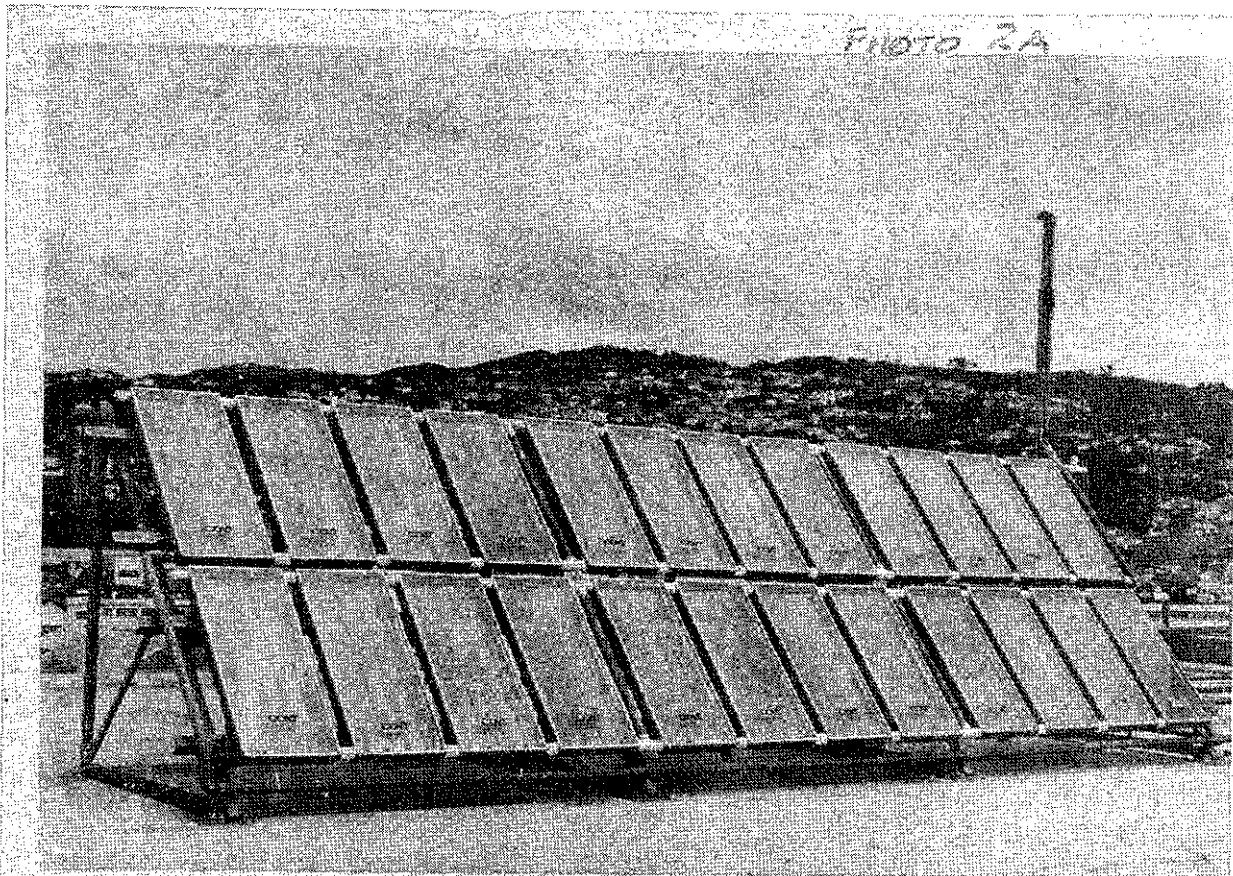

Fig. 1. CROSS SECTION OF THE SITE-BUILT SOLAR COLLECTOR IN VALBY.

<u>Collector K:</u>	1-7-3 (L)	Dirt on cover
	1-1-2	Condensation
	1-1-5	The cover curved and once a cover slipped
	1-3-5 (L)	Outgassing on absorber
	3-1-1 (L)	Dust on absorber



- Collector L: 1-6-1 (L) Glass discolouration (oversized)
5-1-3 (L) Sand accumulation (through ventholes)
5-3-2 (L) Interior case corrosion
8-4-2 (L) One junction of copper piping corrodes



Collector M: No failures (same construction as L)

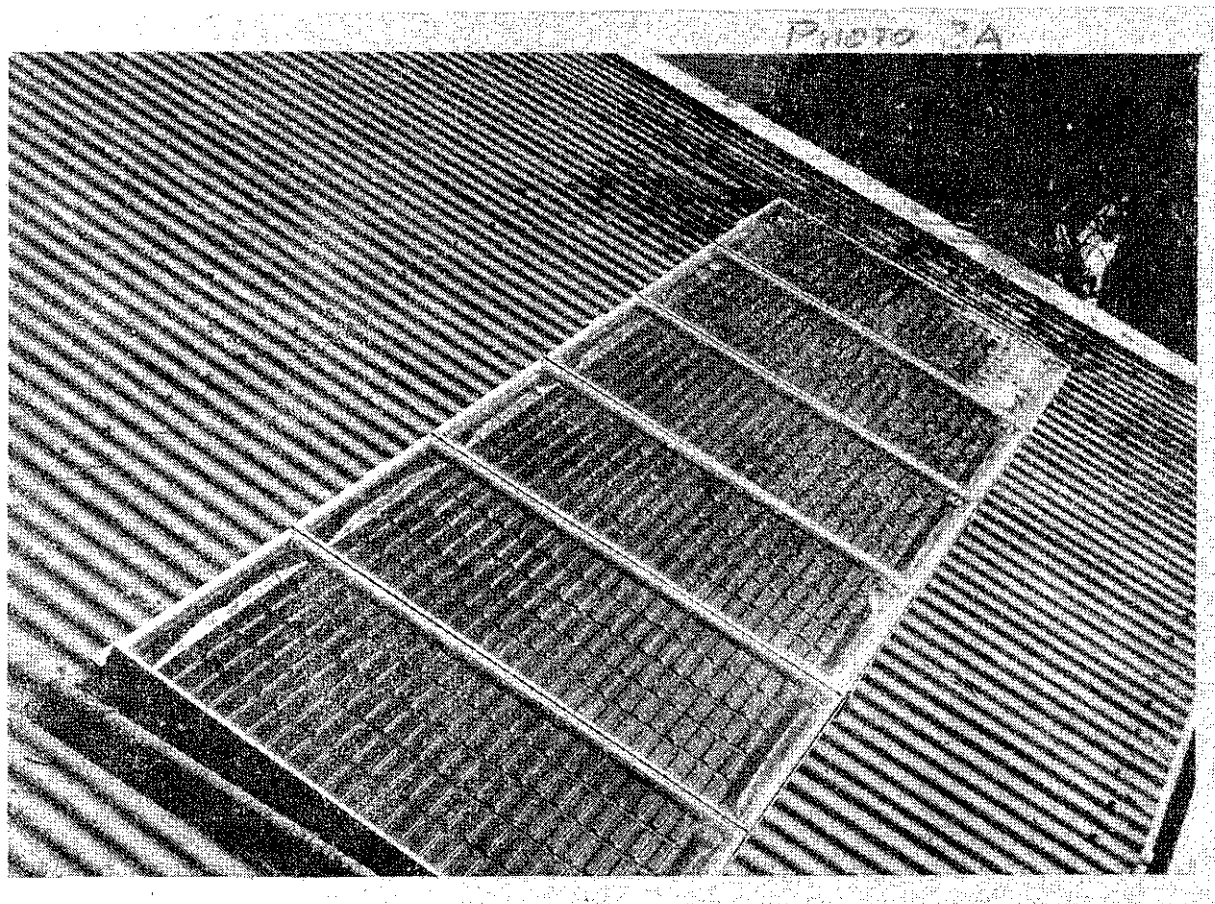

Collector N: 1-1-2 Condensation
2-1-1 Seal separated from enclosure because of:
5-2-1 Enclosure expanded
3-2-2(L) Absorber corroded

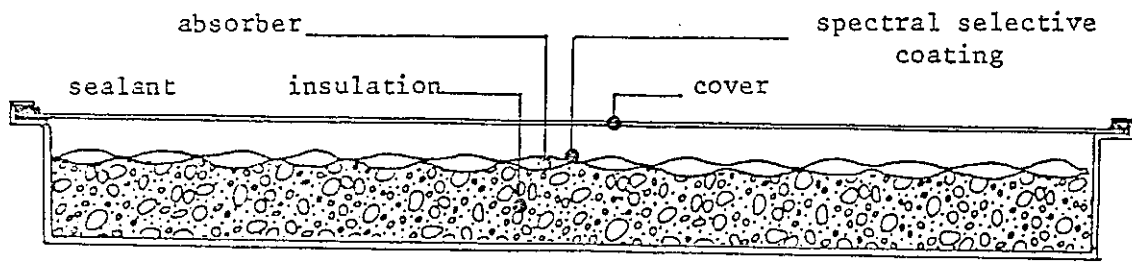

- Collector O: 1-1-2 Condensation
1-7-3(L) Dirt on covers
2-2-2 One collector leaked
3-3-5(L) One absorber leaked because of bad spot welding

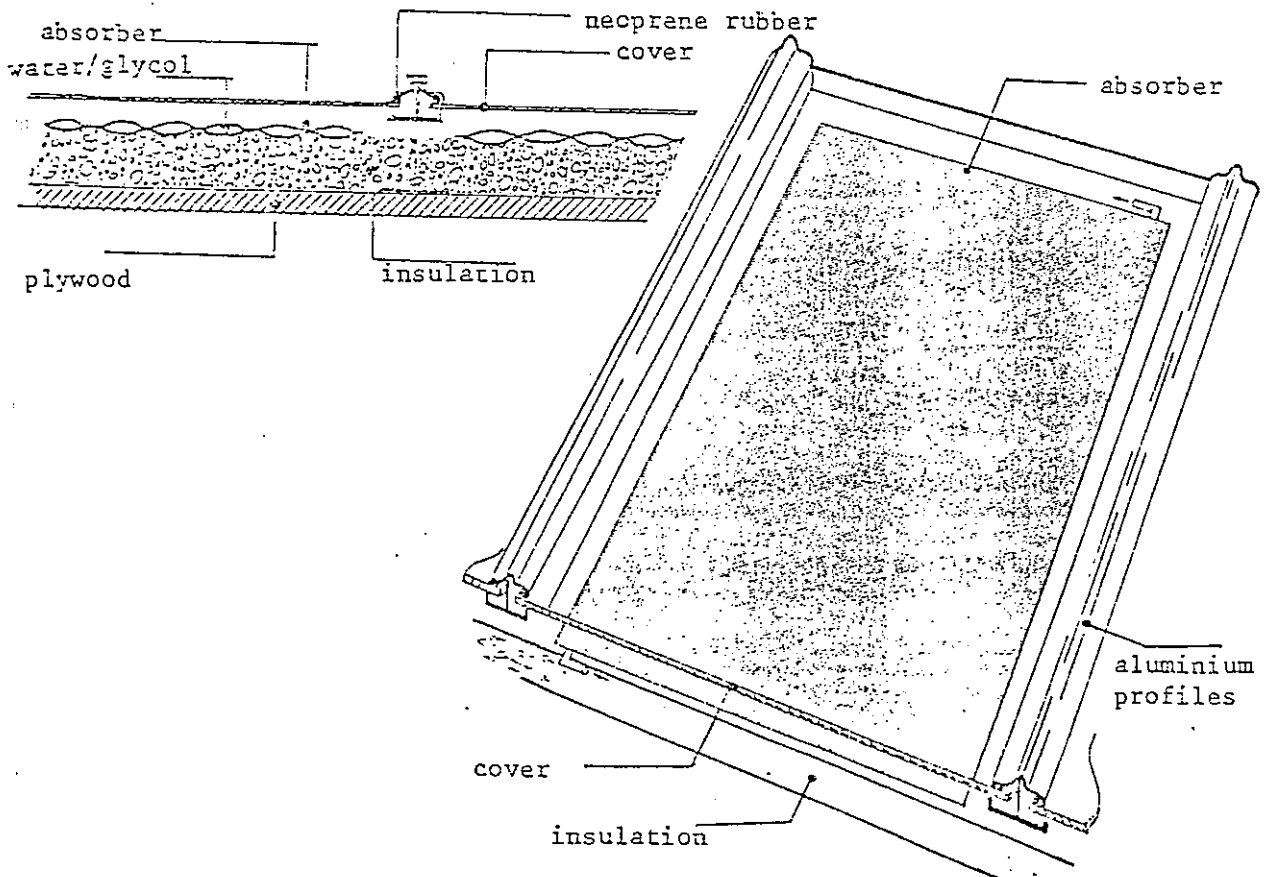

Collector P:

- 1-1-2 Condensation
4-2-1 Glass-wool insulation bagged out (not pressed)
3-2-5 (L) Coating of corners of absorber cracked, leads to corrosion
3-2-2 (L) Sensor corroded

Description of collector:

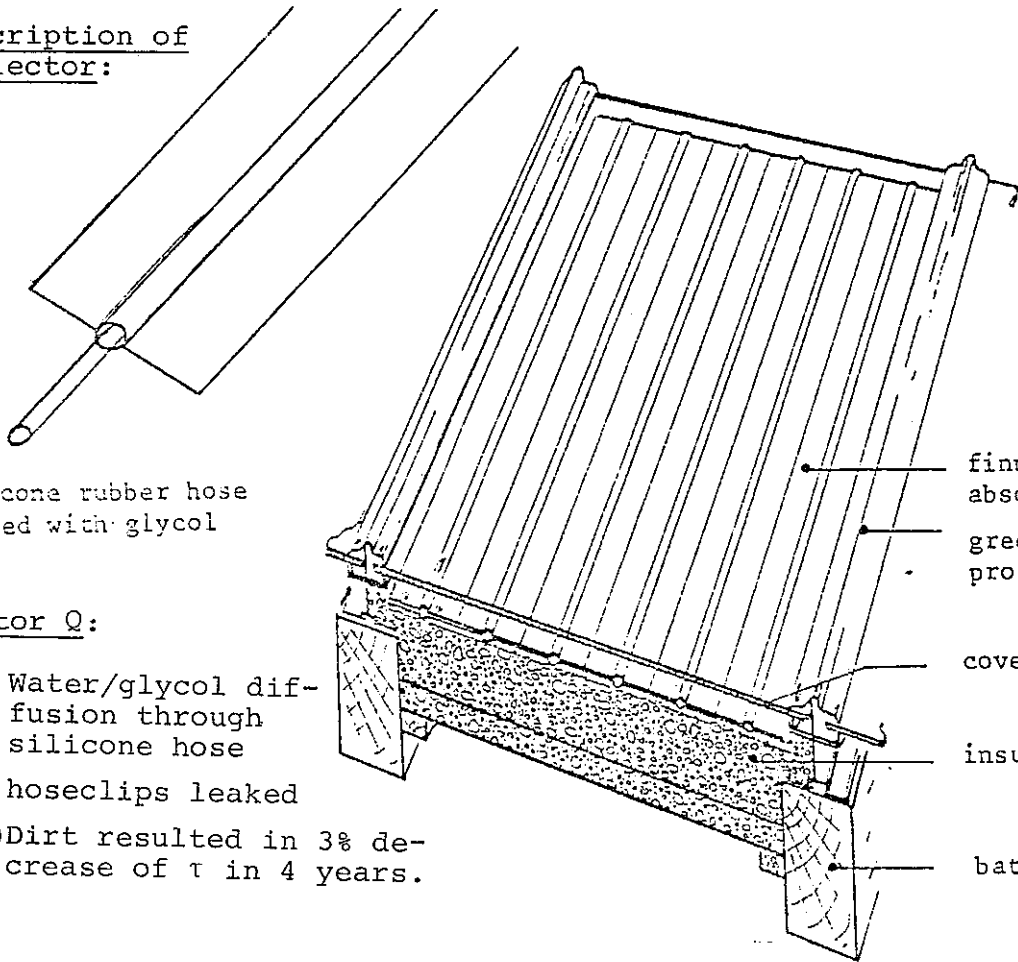

silicone rubber hose filled with glycol

finned tube absorbers

greenhouse profiles

cover

insulation

batten

Collector Q:

3-2-5 Water/glycol diffusion through silicone hose

8-6-1 hoseclips leaked

11-7-1(L) Dirt resulted in 3% decrease of τ in 4 years.

Description of collector:

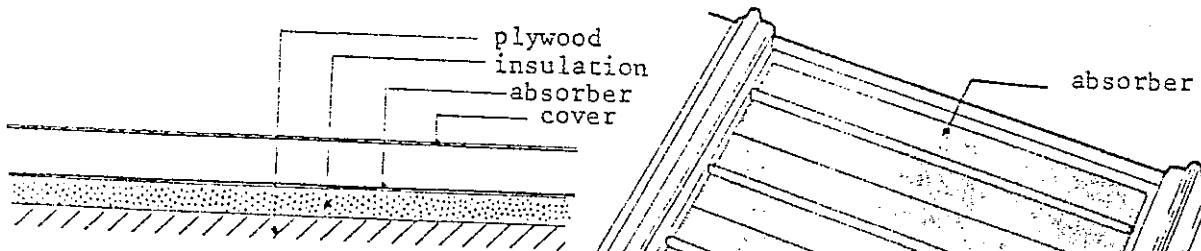

absorber

plywood
insulation
absorber
cover

Collector R:

8-2-2 Filling sensor corroded

8-2-3 Connections a problem several solutions leaked

8-6-3 Drain down caused freezing problems

3-2-2(L) Corrosion of absorber

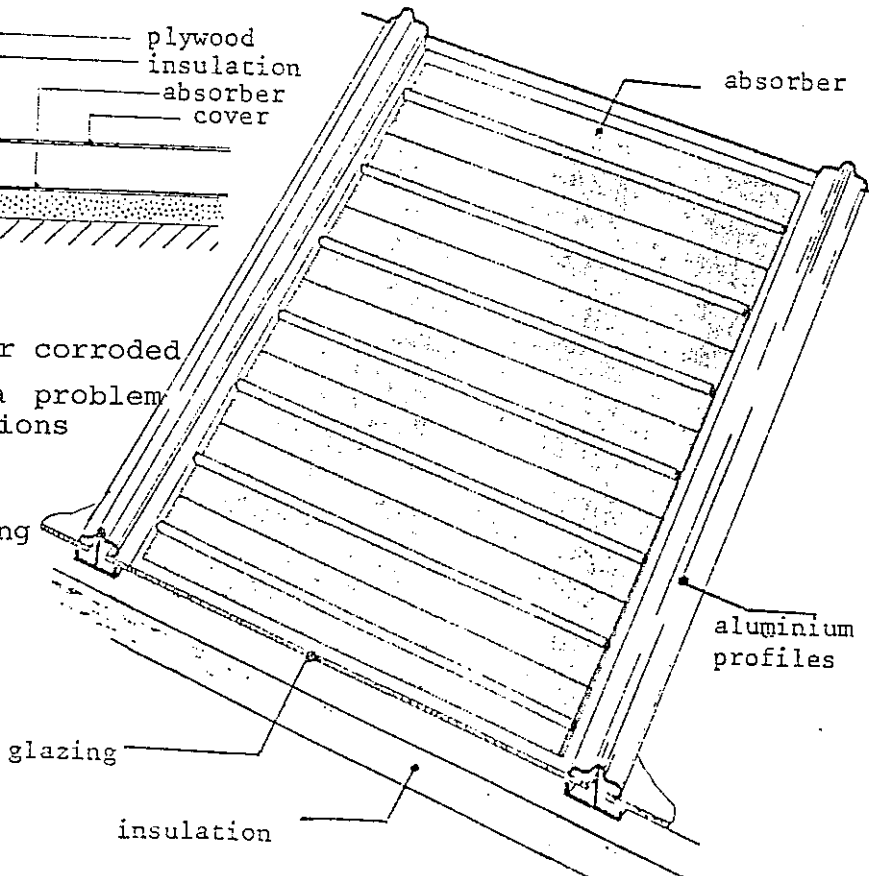

aluminium profiles

glazing

insulation

Collector S:

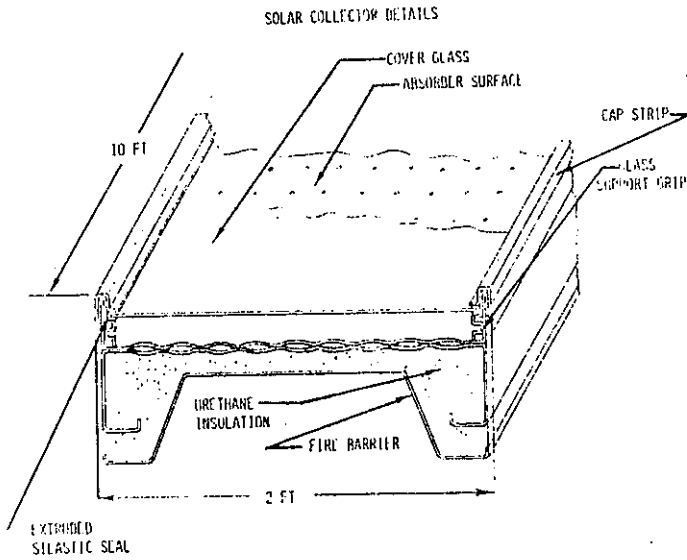

- 1-1-1 Condensation
- 1-7-3(L) Dirt on covers
- 3-1-3(L) Dirt on absorber
- 7-3-5 Paint flaking of flashing
- 7-1-2 Leakage through flashing
- 8-3-2 Leakage of piping system

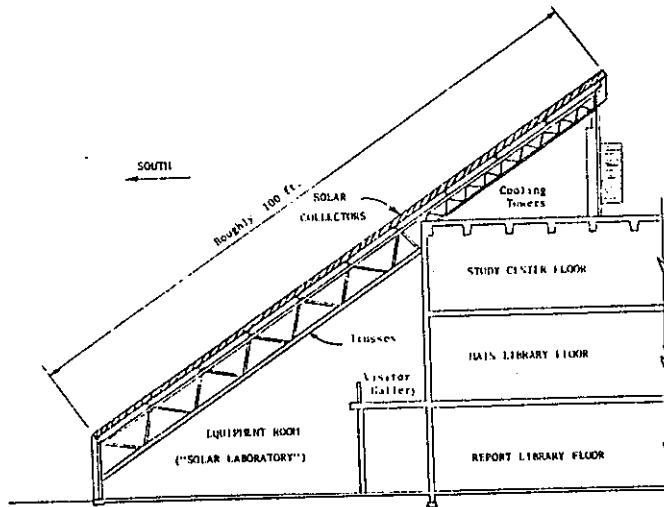

CROSS SECTION, NSR STUDY CENTER, LIS ALABIS SCIENTIFIC LABORATORY

Collector T1: 1-1-2 Condensation
1-7-3(L) Dirt, salt and sand on covers
2-1-1 Sealant failed
4-2-1 Warpage of sideinsulation
5-1-1 Enclosure warpage

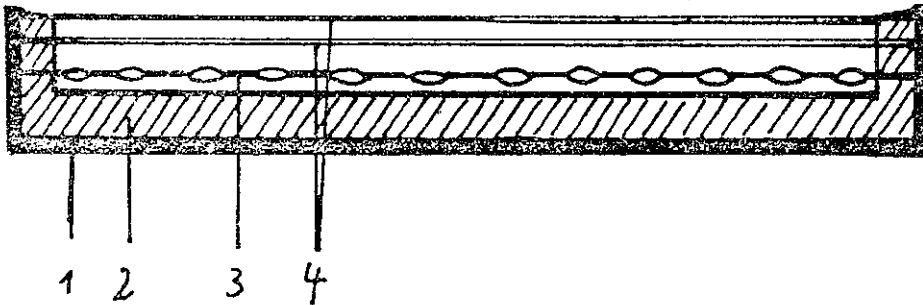

MBB P 43 C

1): stainless steel casing
2): cellular plastic material
3): aluminium rollbond
4): 2 glass panes

Collector T2:

(replacing the T1 collectors)

1-7-3(L) Dirt on covers (salt and sand)
3-3-5 Leakage of attachments
8-4-2(L) Corrosion of connections

CROSS SECTION

Aperture area: 1.1 m²

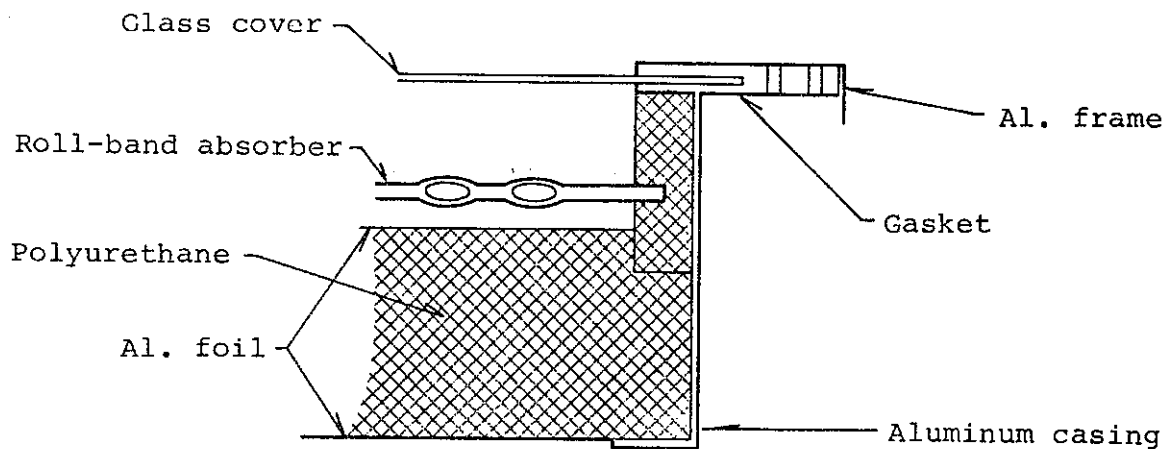

- Collector U:
- 1-1-2 Condensation (all collectors)
 - 3-2-2(L) Corrosion of absorber
 - 3-1-5 Temperature sensor loosened
 - 3-2-5(L) Carbonic deposition in heat exchanger

K03

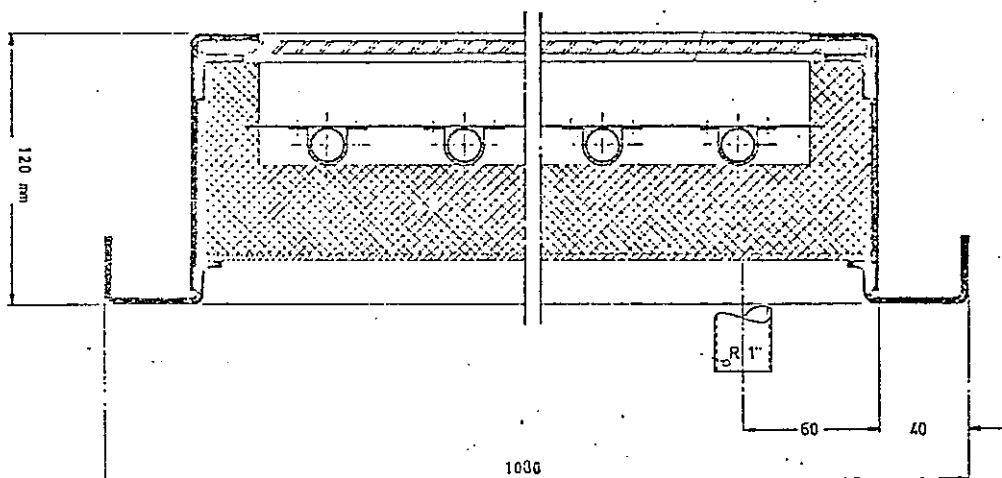

- Collector V:
- 1-1-2 Condensation
 - 1-7-3(L) Dirt on covers
 - 1-2-3(L) Cover degraded by insolation from sun
 - 3-1-2(L) Absorber with grey - white patches

3.3 Development of a new inspection format and objectives for a new inspection round

The first draft of the present report was presented at the IEA Task III experts meeting in Vienna, February 1981. At the meeting it was agreed that the Danish participant, together with the English participant, should develop a new inspection format which should ensure that inspection reports could be made with a better description of the inspected solar collectors, and also make it possible to report good design features of solar collectors.

This new solar collector inspection format is enclosed with this report, in appendix C. To improve inspection of problems and failures of solar collectors, a checklist, based on the experience and the analysis from the above mentioned first draft report, is included in the new format. For different problem- and failure modes one is here supposed to indicate if they are observed, not observed or not possible to inspect, and the frequency of them. A detailed description and evaluation of both failures and good designs should be given in a separate page of the format. The new inspection format also includes a special checklist to investigate design features of the inspected solar collectors.

From a new inspection round it is the aim to be able to establish a catalogue covering common collector problems and failures, and explanations and reasons for the failures. Also a report on good design features should be the result of inspections made according to the new format.

Reference list

- [1] Vest-Hansen, T., E. Mikkelsen & G. Madsen:
Longtime durability of solar collectors. (In Danish).
The Danish Solar Heating Programme, report nr. 7.
Technological Institute, Denmark, 1980.
- [2] Vejsig Pedersen, P.:
Reliability and Durability of Solar Collectors.
Outdoor test of reliability and durability of complete
solar collectors.
Report nr. 80-17. Thermal Insulation Laboratory,
Technical University of Denmark, Denmark 1980.
- [3] Vejsig Pedersen, P.:
Reliability and Durability of Solar Collectors in Denmark.
Paper for the ISES-Congress, Brighton, August 1981.
- [4] National Research Council Canada.
Solar Technical Series nr. 1.
An assessment of problems experienced with operating
solar systems in Canada and the northern United States,
Canada, 1978.
- [5] Wennerholm, H. & K.O. Lagerkvist:
Ageing- and corrosion problems with flat-plate thermal solar
collectors.. (In Swedish).
Statens Provningsanstalt, Sweden, 1979.
- [6] Wennerholm, H. & K.O. Lagerkvist:
Durability of Solar Collectors.
Experiences from inspection of solar heating systems
1979-1980.
Statens Provningsanstalt, Sweden, 1980.
- [7] Chopra, P.S., C.F. Cheny & R.M. Wolosewicz:
Preliminary Evaluation of Selected Reliability,
Maintainability, and Material Problems in Solar Heating
and Cooling Systems.
Argonne National Laboratory, United States, 1978.

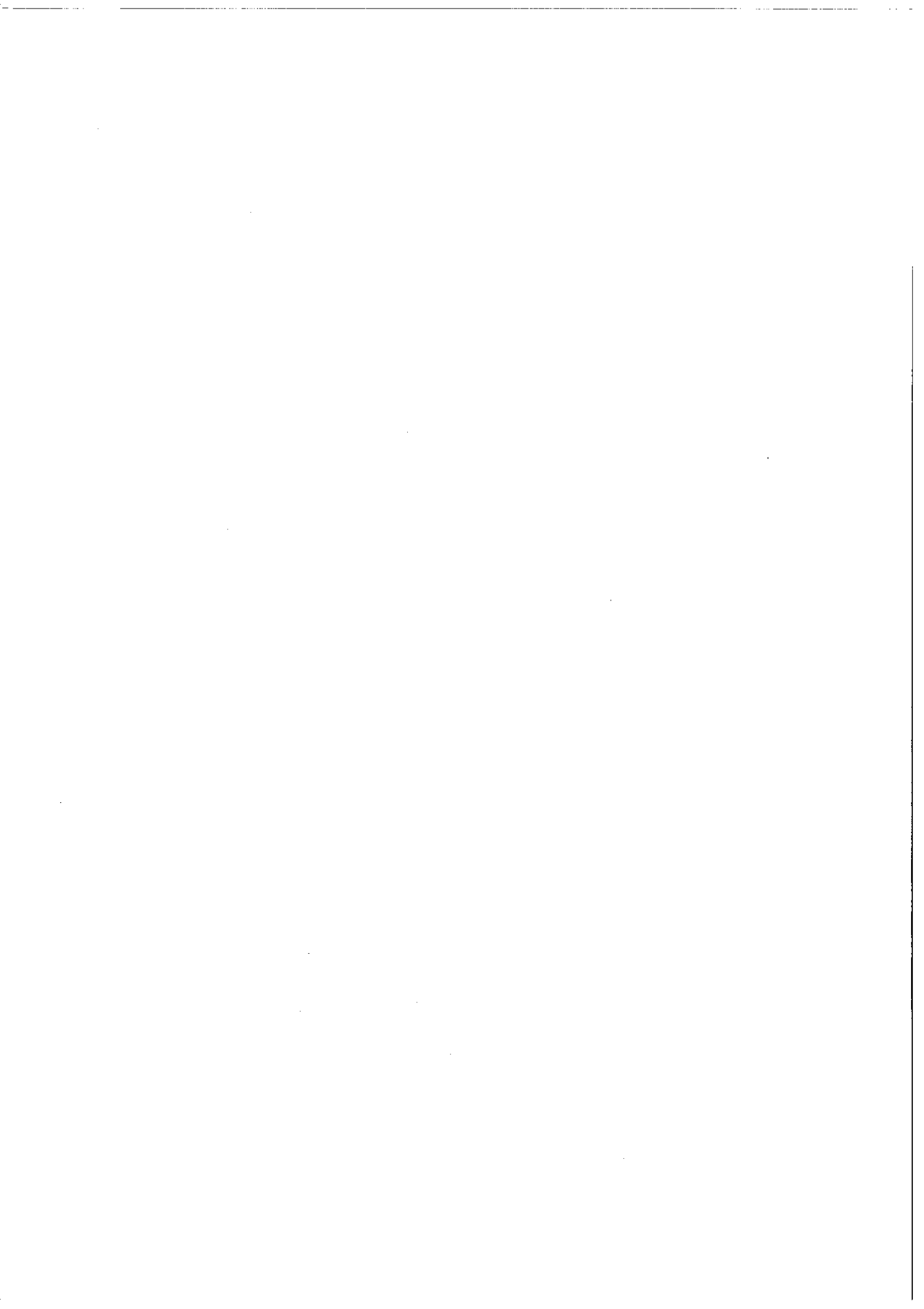

THE FOLLOWING PERSONS AND GROUPS HAVE CONTRIBUTED
WITH INSPECTION REPORTS FOR THIS REPORT:

Manfred Bruck

Austrian Solar and Space Agency, Vienna, Austria

Peder Vejsig Pedersen

Thermal Insulation Laboratory, Lyngby, Denmark

K. Massmeyer

Solar Energy Branch, Kernforschungsanlage, Jülich, Germany

D. E. Brethouwer

Technisch Physische Dienst-THO, Delft, Netherlands

R. F. Benseman

Physics and Engineering Lab., Lower Hutt, New Zealand

Hans E. B. Andersson

National Testing Institute, Boras, Sweden

W. B. Gillett

Solar Energy Unit, University College, Cardiff, England

Elmer Streed

National Bureau of Standards, Washington, U.S.A.

Sakae Tanemura

Solar Research Lab., Nagoya, Japan

INSPECTION REPORTS OF SOLAR COLLECTORS IN SOLAR ENERGY SYSTEMS

Collector	Country	Author	Number
Spencer Solarise Ltd.	United Kingdom	Keith Hayward	A
Don Engineering	-	-	B
Consumer Power Ltd.	-	-	C
Multyflex Ltd.	-	W.B. Gillett	Z
AB Svenska Fläktfabr.	Sweden	K.O. Lagerkvist &	D
John & Co.	-	H. Wennerholm	E
AB Östgötabyggen	-	-	F
Tekno Term Systems	-	-	G
Thermal Insulation Lab.	Denmark	P. Kjaerboe	H
Eversol	-	P. Vejsig Pedersen	I
Danish Solar Heating K/S	-	-	J
-	-	-	K
Colt V & H Ltd.	New Zealand	R.F. Benseman	L
-	-	-	M
Physics & Eng. Lab.	-	-	N
DRU B.V.	Holland	D.E. Brethouwer	O
-	-	-	P
LIPS, Drunen	-	-	Q
-	-	-	R
LASL-Collector Design	U.S.A.	S.W. Moore	S
Messerschmitt	Germany	Heinz Riemer	T1,T2
BBC - Brown Boveri	-	H.D. Talarek	U
Hugo Thalhammer	-	Manfred F. Bruck	V
Sanyo Electric Co.,Ltd.	Japan	K. Hinotani	X *

* This collector is a highly effective evacuated collector. It was not relevant for evaluating flat-plate collectors, but it is included in the appendix.

FLAT PLATE SOLAR COLLECTORS RELIABILITY AND DURABILITY

1
A

DESCRIPTION OF SYSTEM, CONSTRUCTION AND FAILURE OF THE SOLAR COLLECTOR, DISCOVERED DURING EXAMINATION.

Institute: Solar Energy Unit
University College, Cardiff.

Author of report: Keith Hayward

Date and hour for inspection: 13-10-80 1000 hrs Sunny

Location of system: 21 Llandough St., Cathays, Cardiff.

Manufacturer of collector: Spencer Solarise Ltd., Andover, Hampshire.

Installation contractor: Spencer Solarise Ltd.

Date of installation: June 1977

Type of system: Indirect

Total number of collector panels inspected: Three

Heat transfer medium: Oil (Shell oil R 1890)

Safety system: Expansion tank

DESCRIPTION OF SYSTEM, FLOW DIAGRAM, PICTURE OF COLLECTOR:

The solar water heating system consists of three single cover solar panels fitted in a south east facing direction on the roof a terraced house. The three panels are coupled to 120 litre indirect storage tank via a circulating pump. Also included in the system are an expansion tank and differential system controller. Oil is used as the heat transfer fluid.

APPROX. DIMENSIONS OF SOLAR PANEL

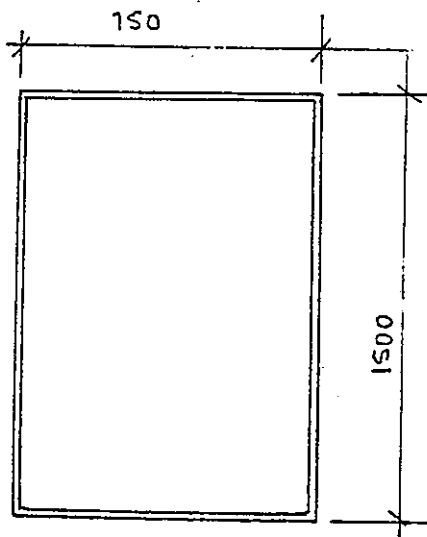

FLAT PLATE SOLAR COLLECTORS RELIABILITY AND DURABILITY

2

DESCRIPTION OF SYSTEM, FLOW DIAGRAM, PICTURE OF COLLECTOR.

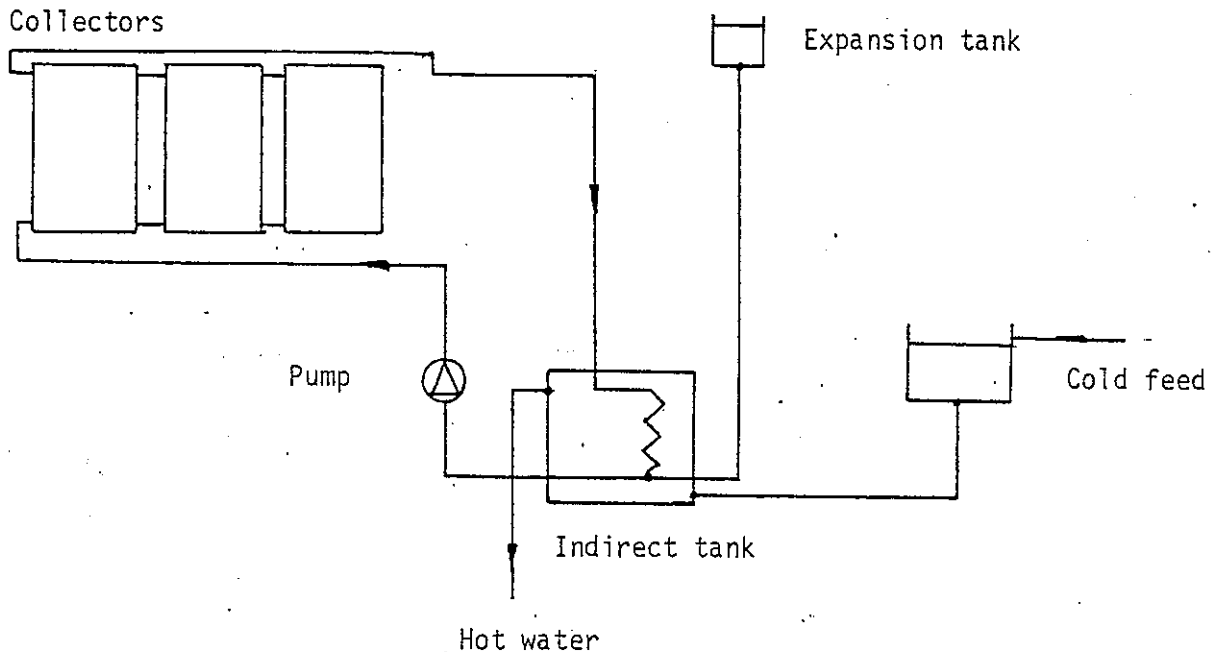

DESCRIPTION OF COLLECTOR.

Spencer Solarise - SS'100' Panel

Aluminium roll bond absorber plate fitted inside a mild steel galvanised casing- see cross section.

1.2 mm Polyester GRP cover is fitted to the sides of the casing with a silicone rubber sealing strip and anodised aluminium trim.

The absorber plate is suspended between 50 mm Rockwool (lined with foil) and a further 30 mm Rockwool around the inside edge of the case.

Four nuts are fitted at the corners of the case for fixing purposes.

The absorber plate is painted matt black.

COLLECTOR CROSS SECTION

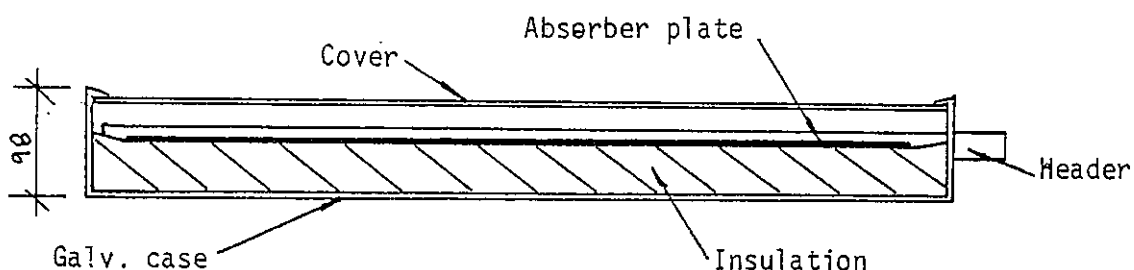

FLAT PLATE SOLAR COLLECTORS RELIABILITY AND DURABILITY

3

COMPONENT DESCRIPTION (materials and manufacture procedure) :

Cover: 1.2 mm Polyester GRP with protective coating (u-v resist)

Absorber coating: Matt black paint

Absorber: Roll bond aluminium

Insulation back: 50 mm Rockwool with foil

Insulation sides: 30 mm Rockwool

Collector enclosure
back and edges: Mild steel (galvanised)

Gaskets and sealants: Silicone rubber glazing strip
EPDM header grommets

Flashing:

Attachments: Support brackets

Other details: None

NUMBER THE FAILURES FOUND DURING THE INSPECTION:

1. Slight dirt on bottom edge of each panel
2. Severe condensation on inside of cover for two panels.
Slight condensation on inside of cover for the remaining panel.
3. Slight sag in cover for each collector.
4. Seal damaged in places.
5. No insulation on external pipework (probably removed by birds)

FLAT PLATE SOLAR COLLECTORS RELIABILITY AND DURABILITY

B

DESCRIPTION OF SYSTEM, CONSTRUCTION AND FAILURE OF THE SOLAR COLLECTOR, DISCOVERED DURING EXAMINATION.

Institute: Solar Energy Unit
University College, Cardiff

Author of report: Keith Hayward

Date and hour for inspection: 10-9-80 1100 hrs Rain showers

Location of system: 112 North Rd., Cardiff, UK

Manufacturer of collector: DON Engineering (South West) Ltd.

Installation contractor: W.J.Creemer Ltd., Cardiff

Date of installation: February 1976

Type of system: Indirect pressurised system

Total number of collector panels inspected: Two

Heat transfer medium: Water/antifreeze

Safety system: Pressure relief valve

DESCRIPTION OF SYSTEM, FLOW DIAGRAM, PICTURE OF COLLECTOR:

The solar water heating system is a separate indirect consisting of two solar panels, domestic hot water cylinder fitted with an indirect coil (heat exchanger), circulating pump, differential system controller, expansion vessel and pressure relief valve.

Simple instrumentation to indicate system pressure, hot tank temperature and ambient air temperature.

APPROX. DIMENSIONS OF SOLAR PANEL

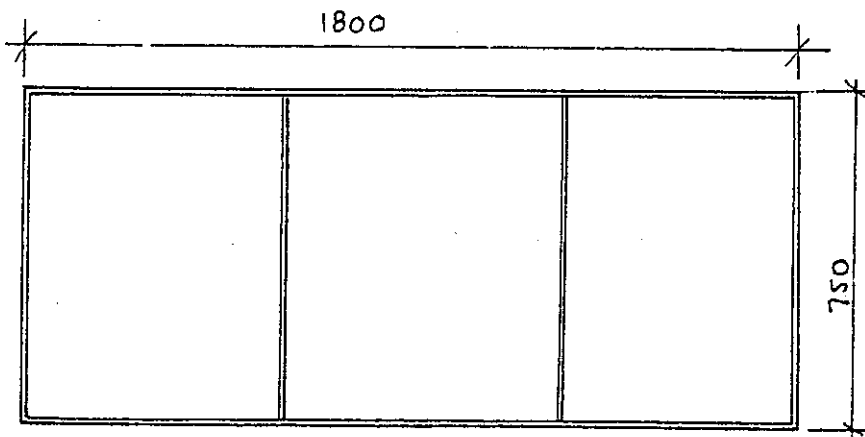

FLAT PLATE SOLAR COLLECTORS RELIABILITY AND DURABILITY

2

DESCRIPTION OF SYSTEM, FLOW DIAGRAM, PICTURE OF COLLECTOR.

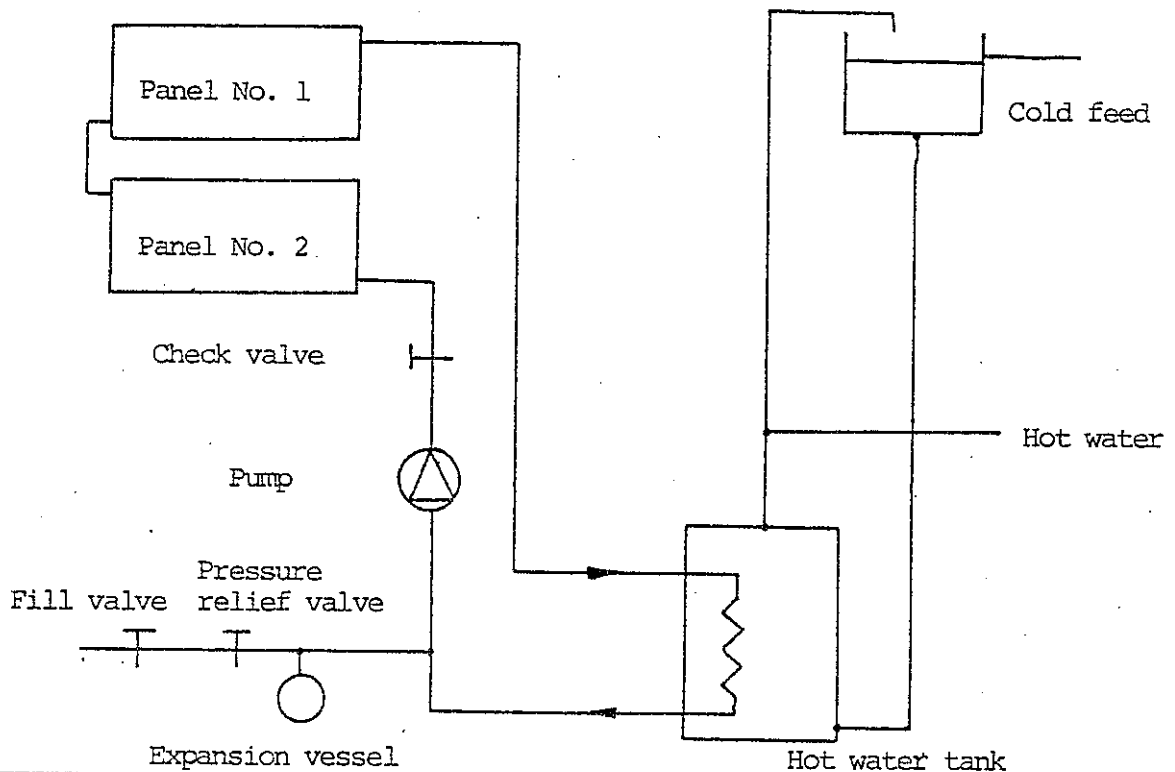

DESCRIPTION OF COLLECTOR.

DN Engineering - MAJOR INDIRECT Panel

Mild steel radiator type absorber plate fitted inside a stainless steel case with a plastic back - see cross section.

4 mm glass cover in three sections to cover complete panel

Glass to case seal:- Neoprene and expanded polyurethane foam.

Back insulation:- Material unknown.

COLLECTOR CROSS SECTION

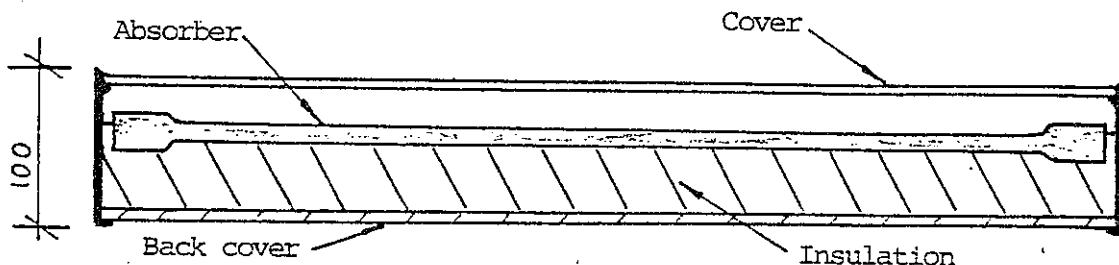

FLAT PLATE SOLAR COLLECTORS RELIABILITY AND DURABILITY

COMPONENT DESCRIPTION (materials and manufacture procedure) :

Cover: 4 mm glass (one panel changed to PERSPEX as a result of glass breakage due to vandalism)

Absorber coating: Matt black paint

Absorber: Mild steel

Insulation back: Material not known - probably glassfibre

Insulation sides: Not applicable

Collector enclosure back and edges: Stainless steel sides, plastic (polyurethane) back

Gaskets and sealants: Neoprene and expanded polyurethane foam

Flashing: Not applicable

Attachments: Mild steel support brackets attached to case

Other details: None

NUMBER THE FAILURES FOUND DURING THE INSPECTION:

1. Slight dirt on outer surface at bottom edge of each panel.
2. Glass breakage on one panel as a result of damage by vandals. Replaced by PERSPEX Acrylic sheet.
3. Inside of each collector not water tight due to poor cover glass seal.
4. Absorber coating severely corroded in places - especially severe at bottom corners of each panel.
5. Inside of collector case covered in moss between case sides and the bottom edge of the absorber plate. This is a result of the poor weather seal.
6. Mild steel supports attached to stainless steel case severely corroded.
7. Panel fluid connections severely corroded - mild steel not adequately protected.

FLAT PLATE SOLAR COLLECTORS RELIABILITY AND DURABILITY

1
C

DESCRIPTION OF SYSTEM, CONSTRUCTION AND FAILURE OF THE SOLAR
COLLECTOR, DISCOVERED DURING EXAMINATION.

Institute: Solar Energy Unit
University College, Cardiff

Author of report: Keith Hayward

Date and hour for inspection: 19-9-80 1430 hrs Rain showers

Location of system: Mountains Motel, Brecon Beacons National Park, UK

Manufacturer of collector: Consumer Power Ltd.

Installation contractor: Vandex Ltd., Barry, S. Glam.

Date of installation: October 1977

Type of system: Indirect

Total number of collector panels inspected: Forty

Heat transfer medium: Water/antifreeze

Safety system:

DESCRIPTION OF SYSTEM, FLOW DIAGRAM, PICTURE OF COLLECTOR:

A large 40 m² system installed as three banks of solar collector in a south facing direction on the roof of the Mountains Motel, Brecon. The panel array is coupled to two indirect storage tanks via a circulating pump and insulated mild steel pipework. A differential system controller operates the system.

APPROX. DIMENSIONS OF SOLAR PANEL

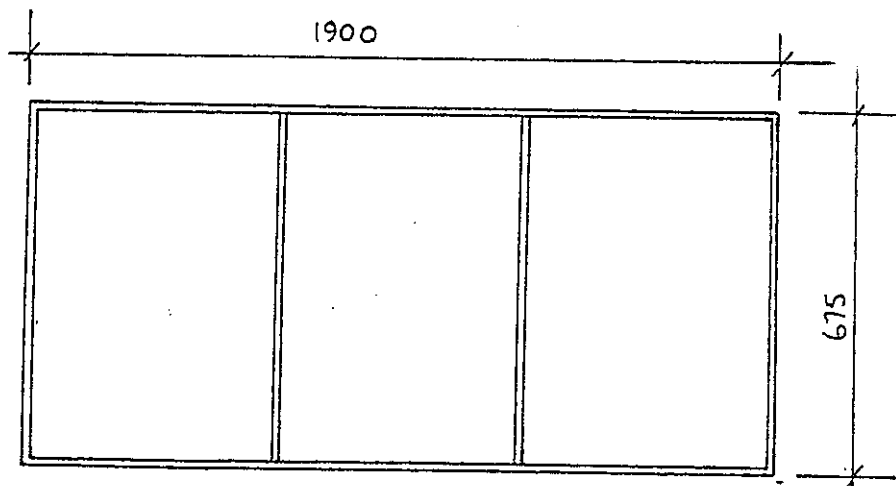

FLAT PLATE SOLAR COLLECTORS RELIABILITY AND DURABILITY

DESCRIPTION OF SYSTEM, FLOW DIAGRAM, PICTURE OF COLLECTOR.

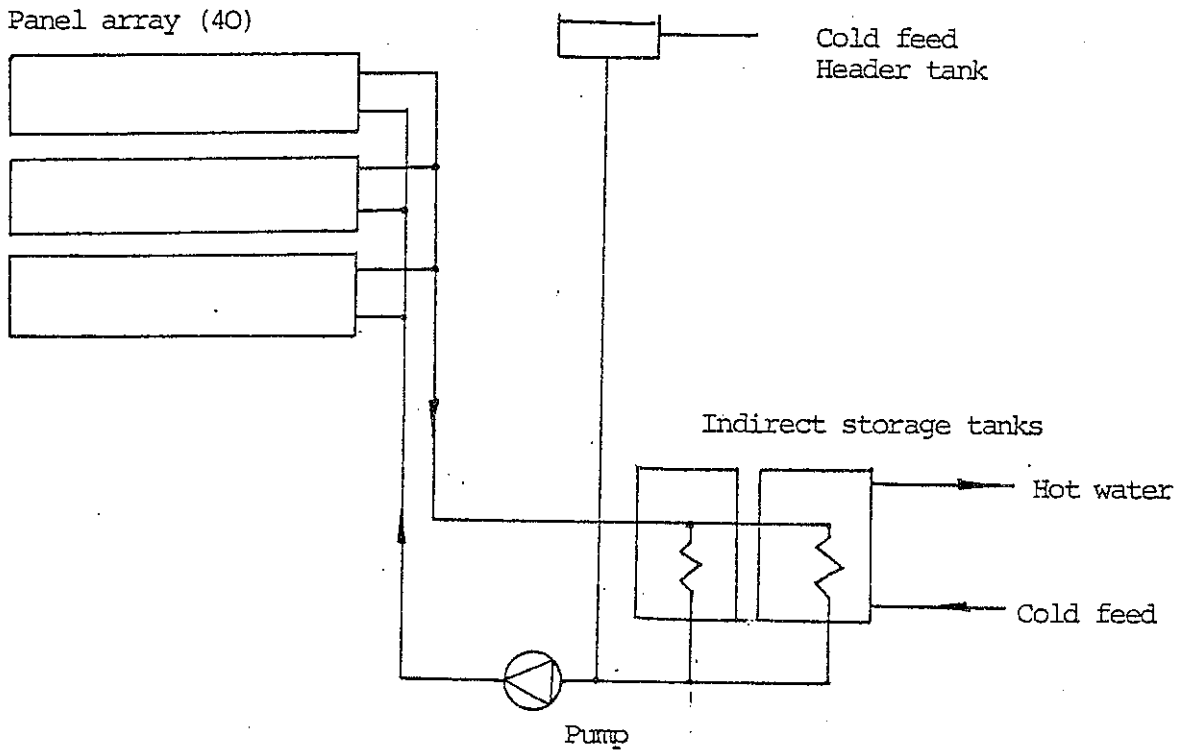

DESCRIPTION OF COLLECTOR.

Consumer Power Ltd. - THERMOSOL Panel

Mild steel radiator type absorber plate fitted inside an extruded aluminium case with a sheet aluminium back - see cross section.
 Glass cover in three sections to cover complete panel
 Glass to case seal:- neoprene.
 Back insulation:- Rockwool

CROSS SECTION THROUGH SOLAR COLLECTOR

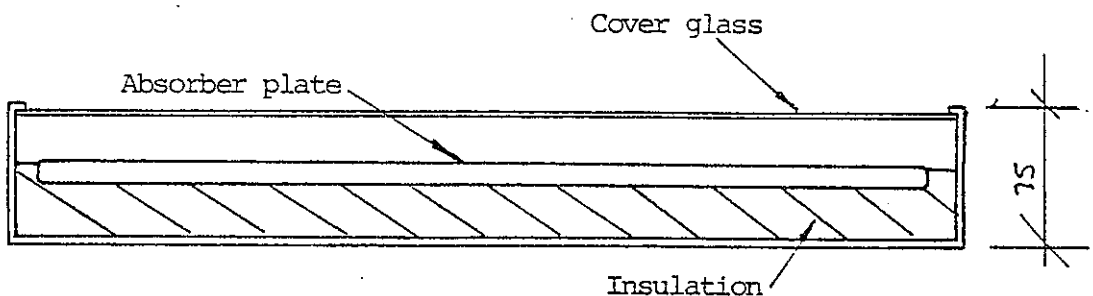

FLAT PLATE SOLAR COLLECTORS RELIABILITY AND DURABILITY

3

COMPONENT DESCRIPTION (materials and manufacture procedure) :

Cover: Glass 4 mm cast

Absorber coating: Matt black paint

Absorber: Mild steel

Insulation back: Rock wool

Insulation sides: Not applicable

Collector enclosure

back and edges: Extruded aluminium sides, sheet aluminium back

Gaskets and sealants: Neoprene

Flashing: Not applicable

Attachments: Mild steel support brackets attached to back of collector

Other details: None

NUMBER THE FAILURES FOUND DURING THE INSPECTION:

1. Glass breakage on eight panels. Other panels damaged but since repaired. Damage caused by poor collector design.
2. Inside of damaged collectors not water tight.
3. Absorber coating discoloured in places. Severe corrosion in collectors with broken cover glass.
4. Mild steel supports attached to back of case corroded.
5. Mild steel screws used to join collector sides together severely corroded.
6. Panel fluid connections severely degraded. Pipe screw clips corroded.
7. Manifold insulation broken in places.

FLAT PLATE SOLAR COLLECTORS, RELIABILITY AND DURABILITY

Description of system, construction and failure of the solar collector discovered during examination.

Institute: Solar Energy Unit, University College, Cardiff, U.K.

Author of report: W. B. Gillett

Date and hour for inspection: 12 Noon, 24 February, 1980

Location of system: National Centre for Alternative Technology Cottage,
Machynlleth.

Manufacturer of collector:
Multyflex Ltd. (Now ceased trading), Absorber from Marston Iberica (Spain)

Installation contractor: (Local Labour)

Date of installation: March/April 1975

Type of system: Indirect Water Heating

Heat transfer media: Water & Ethylene Glycol Antifreeze (9 litres/min)

Safety system: Open vent, antifreeze.

Description of system, flow diagram:

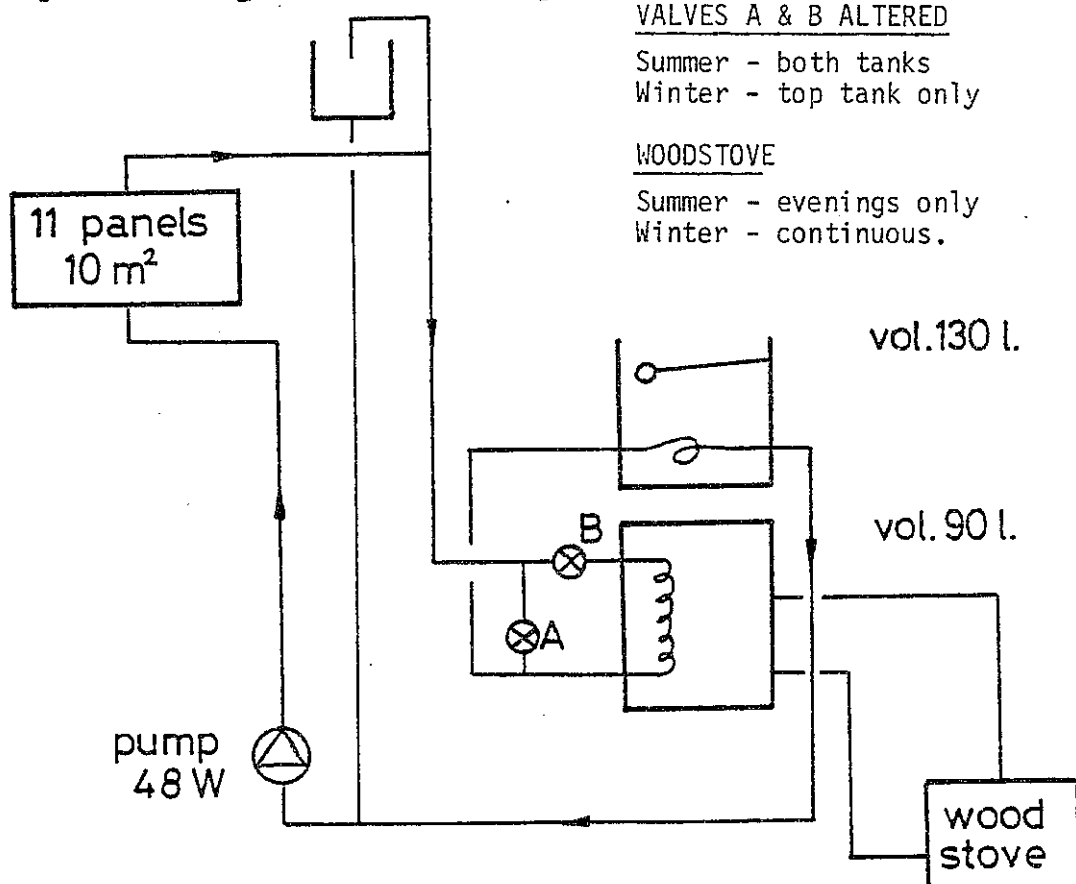

Directions for filling in the sheet is attached at the back.

Component description (materials and manufacturer procedure):

Cover: Glass, 6mm, Half Hammered (Dimples)

Absorber coating: Black Paint (Enamel)

Absorber: Roll-Bond Aluminium

Insulation back: Poly Isocyanurate foam, sprayed directly onto absorber.
Thickness ~ 2 cm + Glass fibre thickness 5 cm.

Insulation sides: Glass fibre overlaps the sides.

Collector enclosure back and edges: Patent glazing built into roof between roof trusses at 600 mm centres. Large gap left at bottom.

Gaskets and sealants: Absorber spaced from glass by 1 cm gasket of expanded neoprene foam (self adhesive to absorber)

Flashing: Reinforced bitumen felt (repaired with recent patches)

Attachments: Absorber fixed to roof trusses by 4 angle brackets.

Other details:

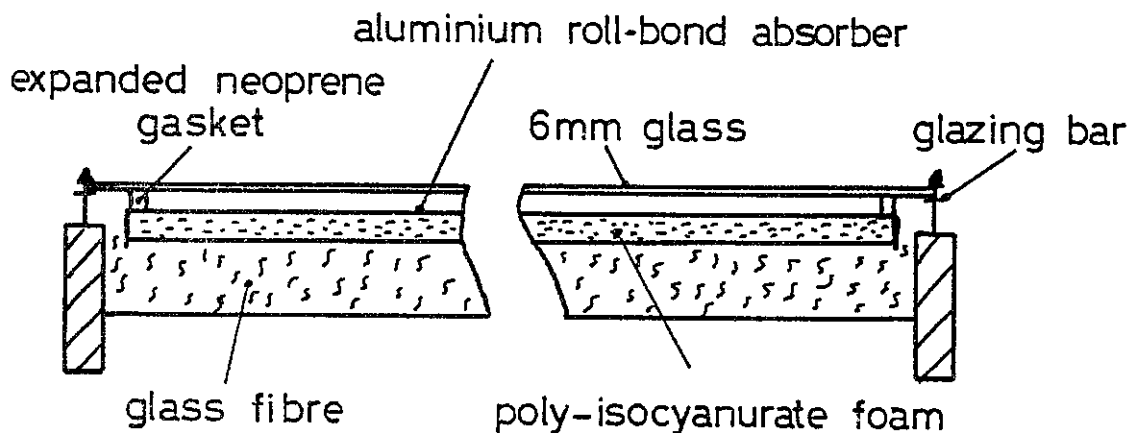
Description of collector:

Remarks

Number (see checklist)

Description:

Potential cause:

Possible remedy to avoid failure during production
and to mend it on the operating collector:

1. Condensation present on all collectors, mainly near top.
2. Covers dirty, but not seriously affected.
3. Absorber coating dirty, corroded from drips of condensation - Grey in colour with white patches.
4. Flashing in very poor condition, partially repaired by patches.
5. One glass cracked from 2/3 distance across base to 0.5 m up one side. May be caused by ladder or possibly a thermal crack.
6. Expanded neoprene gasket shrunk, warped and in many places missing altogether. Will require replacement or another means of isolating absorber from the roof timbers.
7. Sealant rope in glazing bars rotten. Requires replacement. Could later cause glass failure.

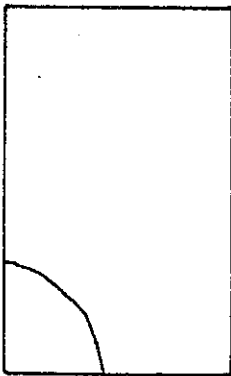

glass crack

FLAT PLATE SOLAR COLLECTOR, RELIABILITY AND DURABILITY

Checklist to be used when examining solar collectors*

Failure Detail	Con- densa- tion	Dirt or deposite	discolo- ration	Corro- sion	Outgas- sing	Flak- ing	Crack- ing	War- page	Leak- age	Break- age	Other degene- ration
Covers	1	2			NF		5			5	
Absorber coating	1	3	3	3							
Absorber											
Insulation	NF										
Enclosure											7
Flashing			4			4					
Gasket								6			
Sealants											
Attachments											
Heat transfer media											NC
Remaining details											

*Number remarks for failure, Fill in NF for no failure, NA for not applicable and NC for not checked.

FLAT PLATE SOLAR COLLECTORS, RELIABILITY AND DURABILITY
D

Description of system, construction and failure of the solar collector discovered during examination.

Institute: National Institute for Testing
P.O. Box 857, 501 15 Borås, Sweden

Author of report: K.O. Lagerkvist
H. Wennerholm

Date and hour for inspection: 1980-03-11, all day long

Location of system: Täby, Stockholm

Manufacturer of collector: AB Svenska Fläktfabriken

Installation contractor: Sven Tyrén AB , Stockholm

Date of installation: Spring 1978

Type of system: Space and water heating

Heat transfer media: Water and glycol

Safety system: Antifreeze

Description of system, flow diagram:

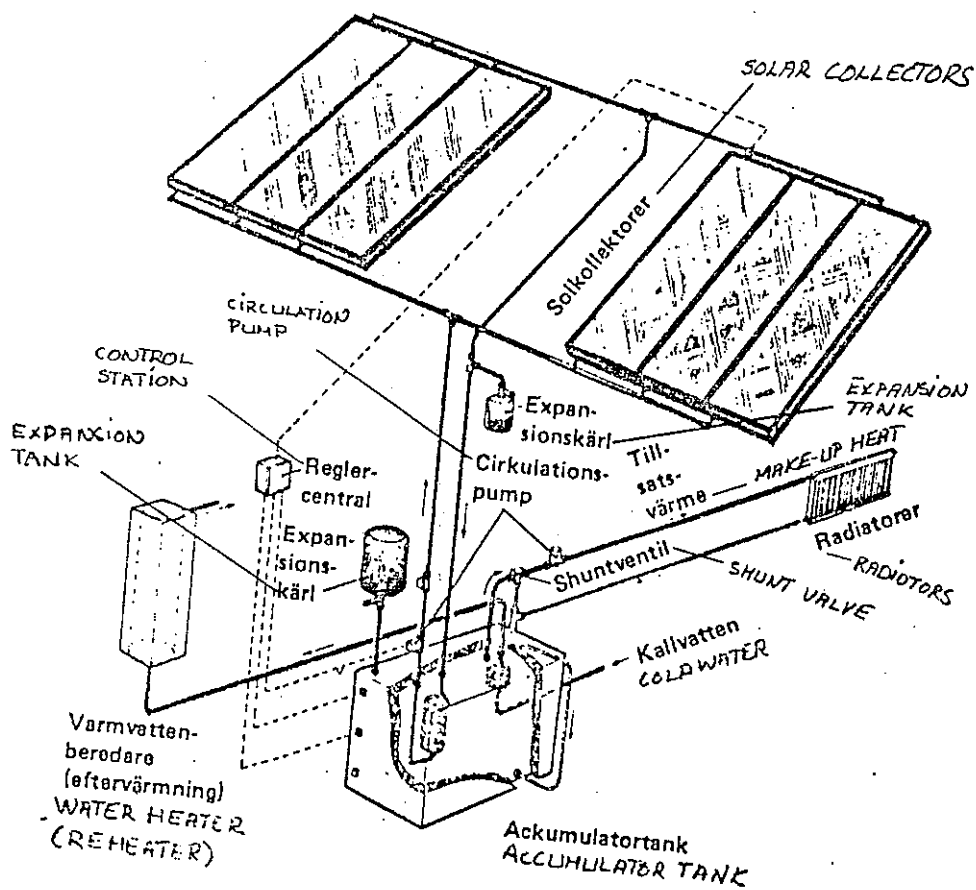

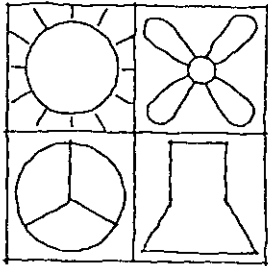

System 44

- Solar collector, approx. 24 m²
- Heat pump (air/water) for the hot air unit and the pre-heating of domestic hot water
- Heat storage, approx. 10 m³
- Electric hot water heater
- Hot air unit
- Mechanical fresh air and exhaust air system with heat recovery
- Controls for the reduction of the temperature of rooms and the simultaneous reduction of the fresh air and exhaust air flow rates.

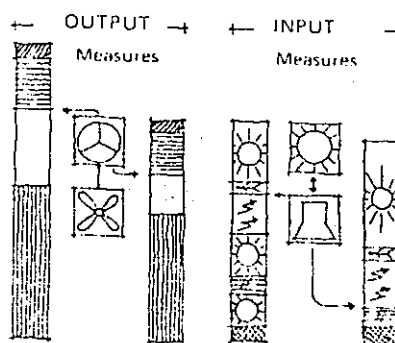
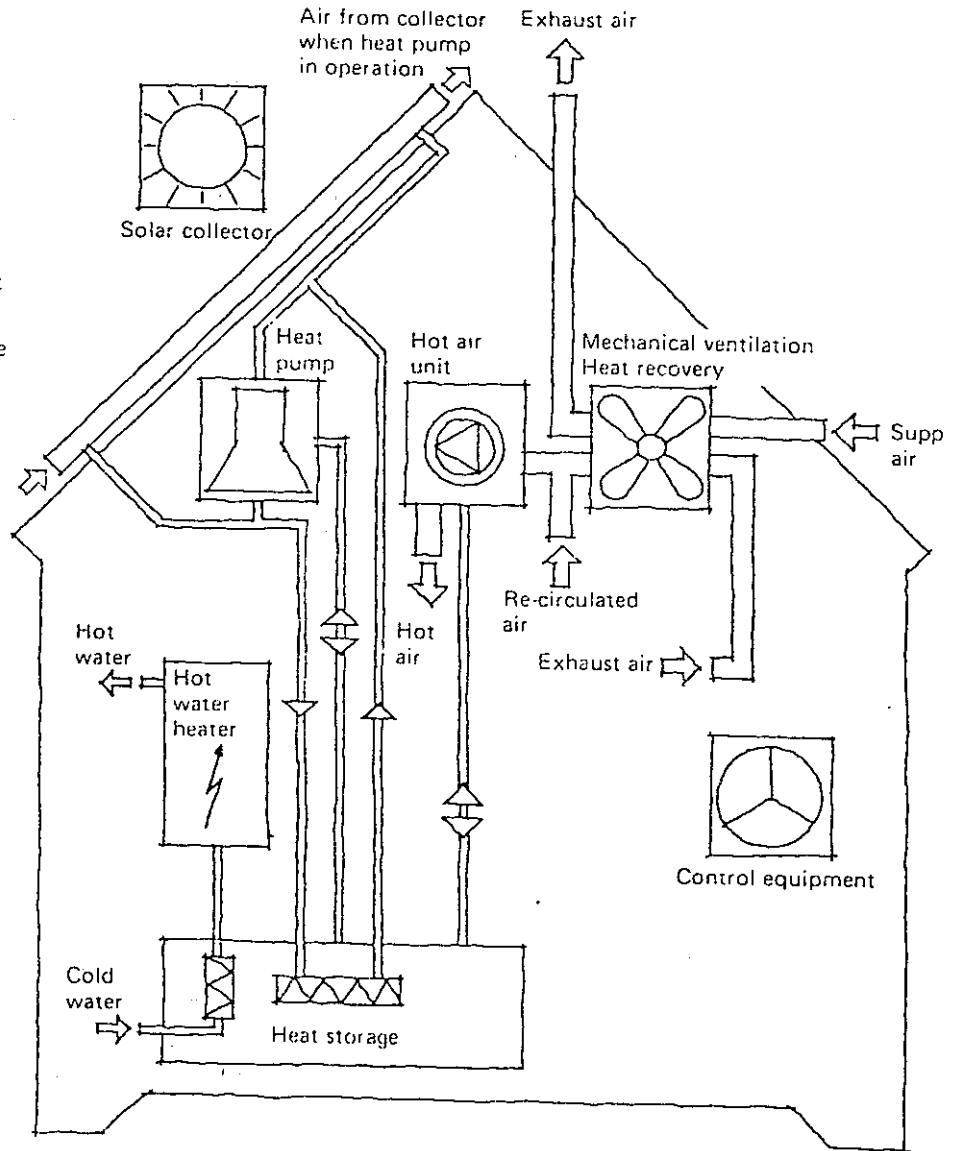

OUTPUT	INPUT
Miscellaneous	Solar radiation
Warm waste water	People (100 W/person)
Exhaust air	Electricity
Heat loss through windows, floors, walls and roof	Electricity (heat) from hot water heater
	Heat to space heating system

In this case solar heating, the heat pump, heat recovery and the control systems work together. The total theoretical saving is 13000 kWh which is divided somewhat complexly between the different systems.

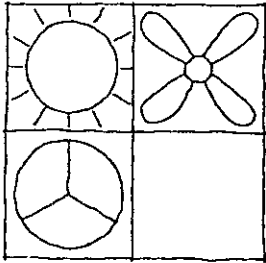

System 42

- Solar collector, approx. 24 m², for detached houses 20 m²
- Heat storage, approx. 10 m³, for terrace houses approx. 3 m³, used for the hot air unit and the pre-heating of domestic hot water
- Electric hot water heater
- Hot air unit
- Mechanical exhaust air and fresh air system with heat recovery
- Control equipment for the reduction of the temperature of rooms and the simultaneous reduction of fresh air and exhaust air flow rates.

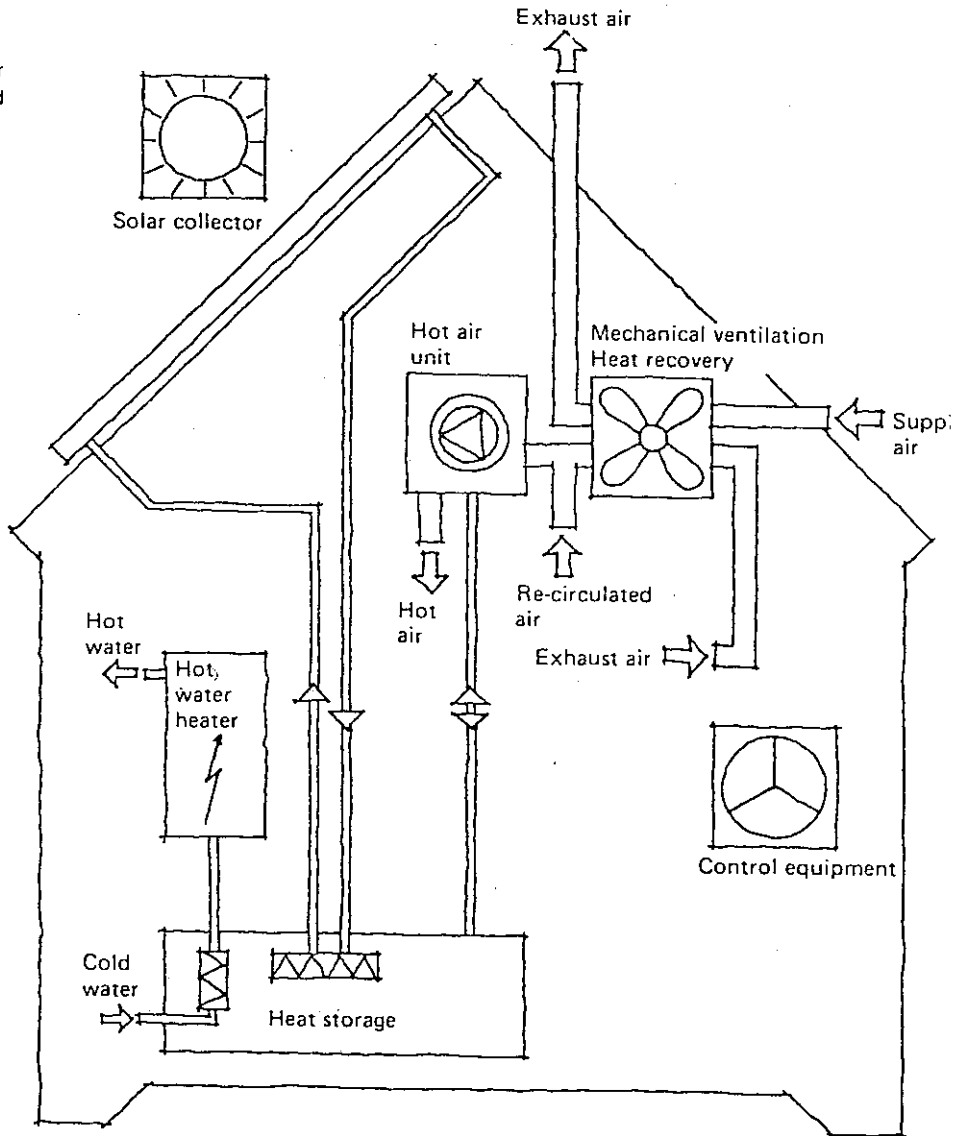

Solar heat for domestic hot water covers half of the demand. Saving 2500 kWh. Solar heat to the hot air system varies for the detached houses and terrace houses. We have estimated that it is approx. 2000 kWh. The heat exchanger and the control system works in a complicated manner when several systems are brought together. The total saving for the detached houses is approx. 10000 kWh and for the terrace houses 7 8000 kWh.

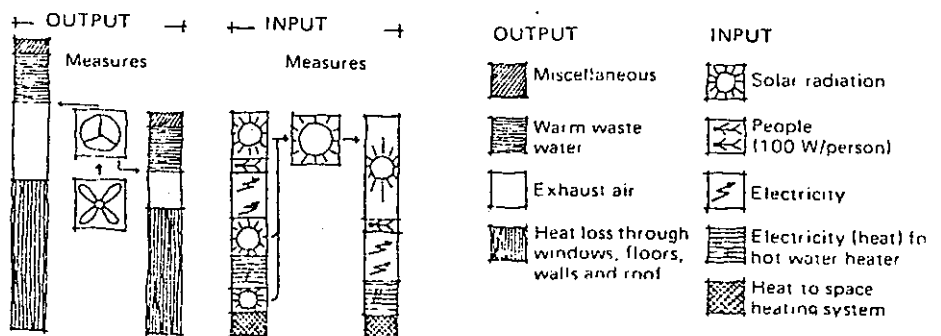

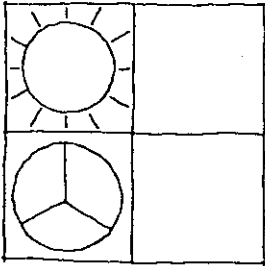

System 32

- Electric radiators
- Solar collector, approx. 8 m²
- Heat storage approx. 3 m³ for the heating of domestic hot water
- Electric hot water heater
- Mechanical exhaust air system
- Controls for the reduction of the temperature of rooms and the reduction of the exhaust air flow rates. Manual or timer-controlled.

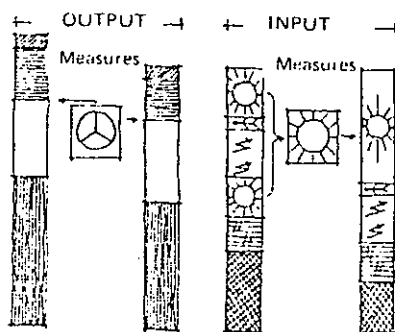
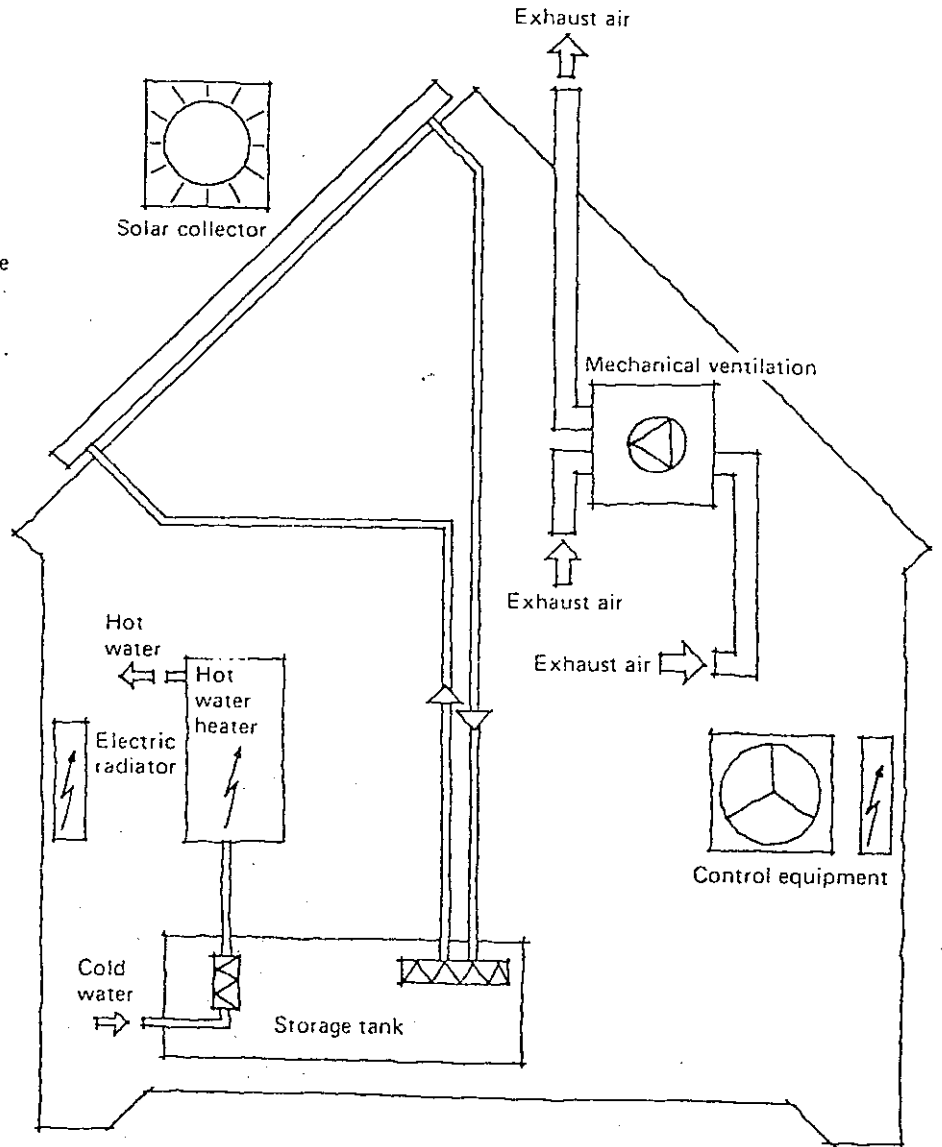

OUTPUT	INPUT
Miscellaneous	Solar radiation
Warm waste water	People (100 W/person)
Exhaust air	Electricity
Heat loss through windows, floors, walls and roof	Electricity (heat) for hot water heater
	Heat to space heating system

The additional heat provided by the sun is not that great, perhaps 2500 kWh. Some leakage of heat from the tank also occurs. At a guess 1000 kWh heat leaks into the house.

Component description (materials and manufacturer procedure):

Cover: Single, glass fiber reinforced

Absorber coating: Cu_2O

Absorber: Copper

Insulation back Polyurethane

Insulation sides: -

Collector enclosure

back and edges: Black painted galvanized steel

Gaskets and sealants:

Flashing:

Integral mounting within the roof construction

Attachments:

Other details:

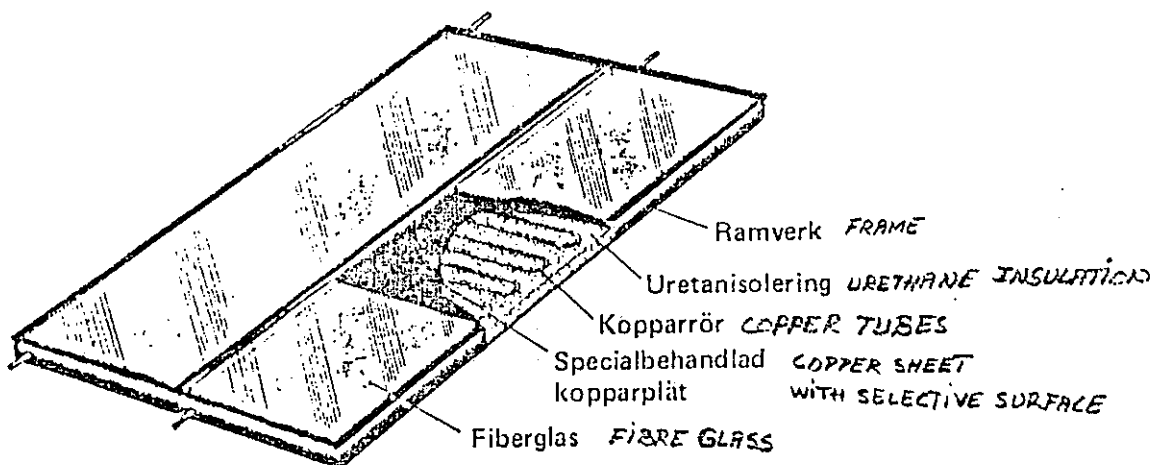
Description of collector:

Number of collectors 36
 Collector area /m² 4
 Total collector area /m² 144

Address:

Täby, Stockholm
 Sweden

FLAT PLATE SOLAR COLLECTOR, RELIABILITY AND DURABILITY

Checklist to be used when examining solar collectors*

Failure Detail	Con- densa- tion	Dirt or de- posit	discol- oration	Corro- sion	Outgas- sing	Flak- ing	Crack- ing	War- page	Leak- age	Break- age	Other de- gene- ration
Covers	1	2	3								
Absorber coating											
Absorber				4							
Insulation											
Enclosure				5							
Flashing											
Gasket											
Sealants											
Attachments											
Heat transfer media											
Remaining details											

*Number remarks for failure. Fill in NF for no failure, NA for not applicable and NC for not checked.

Remarks

Number (see checklist)

Description:

Potential cause:

Possible remedy to avoid failure during production and to mend it on the operating collector:

1. Condensation was observed on the inside, down in the lower part of most covers.
2. 14 out of 36 covers dirty on the outside
3. 6 covers out of 36 are faint yellow because of aging.
4. Beginning corrosion down in the lower edge on 9 absorbers out of 36.
5. Battens of galvanized steel are rusty on 11 collectors out of 36.

Component description (materials and manufacturer procedure):

Cover:	GRP
Absorber coating:	Selective
Absorber:	Aluminum
Insulation back	Polyurethane
Insulation sides:	Polyurethane
Collector enclosure back and edges:	Black painted galvanized steel
Gaskets and sealants:	Rubber
Flashing:	Aluminum
Attachments:	
Other details:	

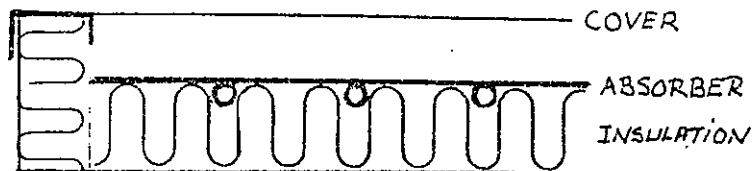
Description of collector:

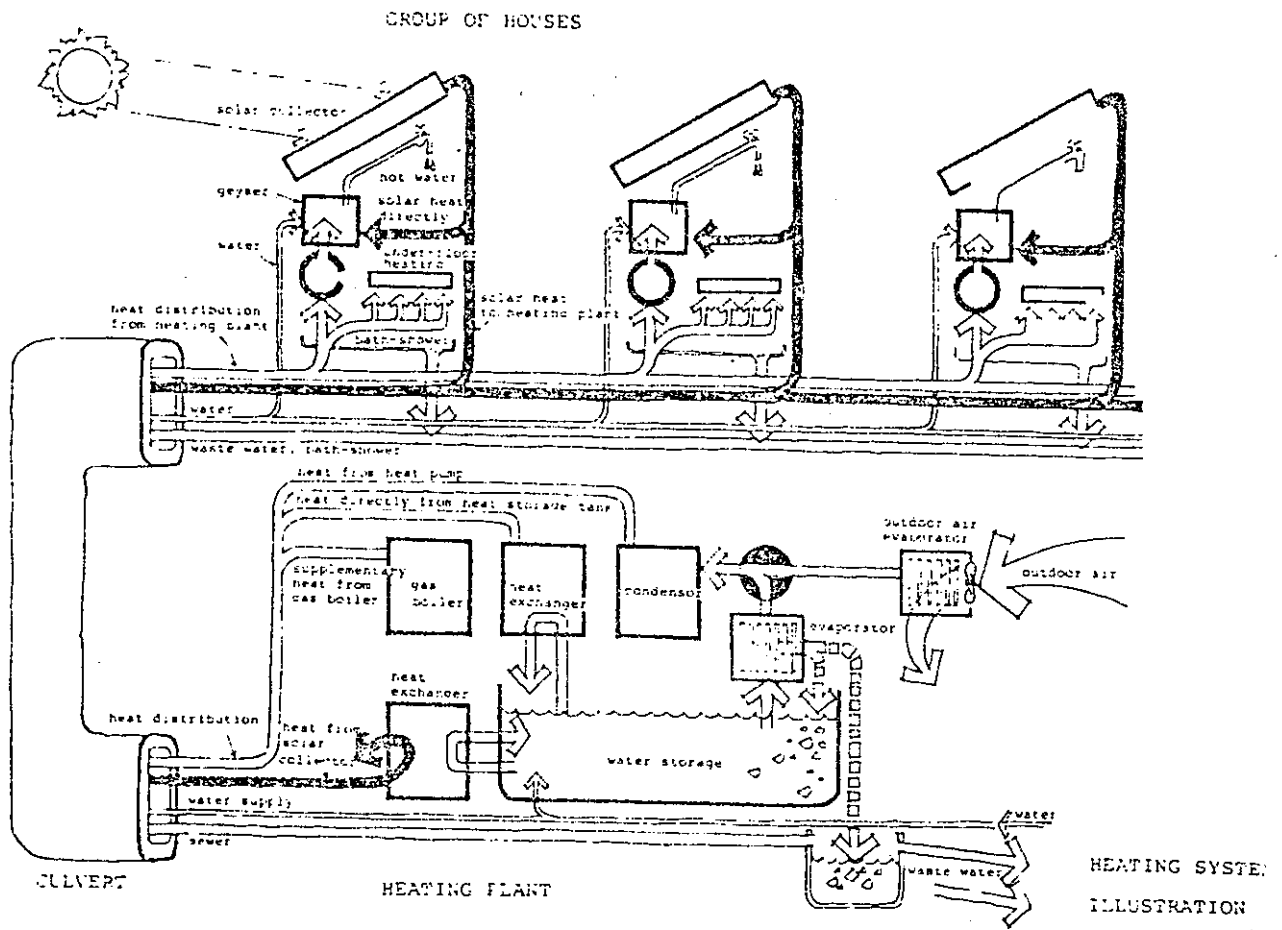

THE BRANCHULT PROJECT

HEATING SYSTEM
ILLUSTRATION

Remarks

Number (see checklist)

Description:

Potential cause:

Possible remedy to avoid failure during production
and to mend it on the operating collector:

1. No condensation was observed at the time for inspection, but have been observed earlier from time to time.
2. Some soot, grime and paint drops outside the cover
3. Faint yellowish because of aging
4. A few supporting rods inside the cover have partly come unstuck.
5. The covers bulge when the sun is shining because the collectors are rather airtight

Number of collectors 60
 Collector area /m² 2.37
 Total collector area /m² 142

Address:

Brånåhult
 BORÅS, Sweden

FLAT PLATE SOLAR COLLECTOR, RELIABILITY AND DURABILITY

Checklist to be used when examining solar collectors*

Failure Detail	Con- densa- tion	Dirt or de- posit	discol- oration	Corro- sion	Outgas- sing	Flak- ing	Crack- ing	War- page	Leak- age	Break- age	Other de- gene- ration
Covers	1	2	3				4	5			
Absorber coating											
Absorber											
Insulation											
Enclosure											
Flashing											
Gasket											
Sealants											
Attachments											
Heat transfer media											
Remaining details											

*Number remarks for failure. Fill in NF for no failure, NA for not applicable and NC for not checked.

FLAT PLATE SOLAR COLLECTORS, RELIABILITY AND DURABILITY
F

Description of system, construction and failure of the solar collector discovered during examination.

Institute: National Institute for Testing
P.O. Box 857, S-501 15 BORÅS, Sweden

Author of report: K.O. Lagerkvist
H. Wennerholm

Date and hour for inspection: 1980-03-05

Location of system: Linköping, Sweden

Manufacturer of collector: AB Östgötabyggen, Linköping

Installation contractor: AB Östgötabyggen

Date of installation: Summer 1975

Type of system: Space and water heating

Heat transfer media: Water

Safety system: Evacuation, nitrogen gas against corrosion

Description of system, flow diagram:

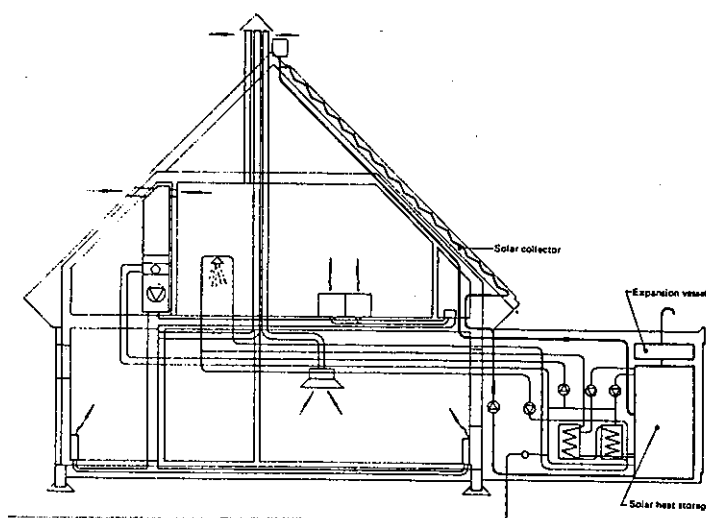

Fig Solar heating system

Directions for filling if the sheet is attached at the back.

Component description (materials and manufacturer procedure):

Cover:	Two layer glass, 5 + 5 mm
Absorber coating:	Black chrome
Absorber:	Galvanized steel
Insulation back	15 cm mineral wool
Insulation sides:	-
Collector enclosure back and edges:	Plywood
Gaskets and sealants:	Silicone
Flashing:	Integral mounting within the roof construction
Attachments:	
Other details:	

Description of collector:

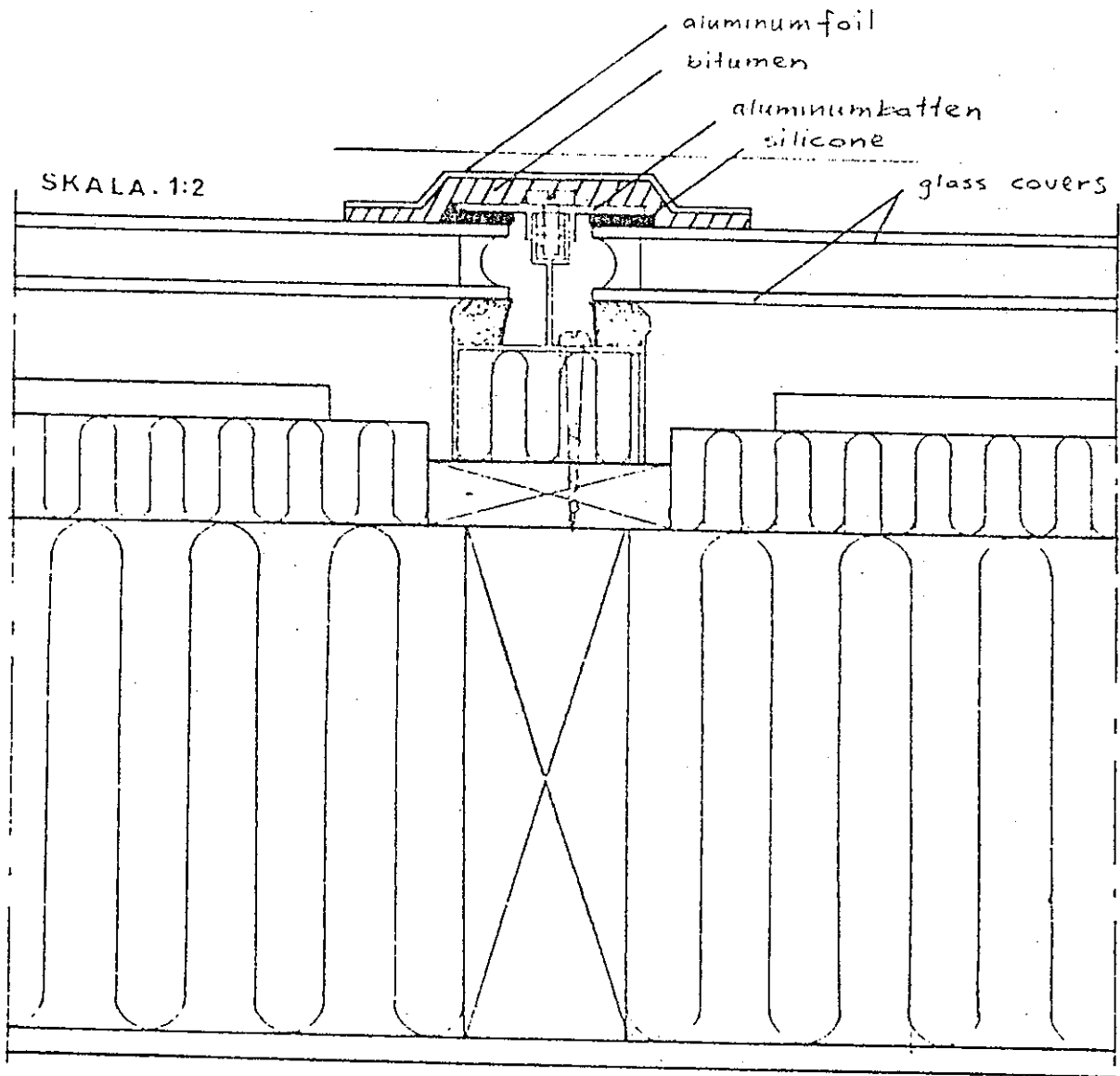

Address: _____
 Hjulbro
 LINKÖPING, Sweden

FLAT PLATE SOLAR COLLECTOR, RELIABILITY AND DURABILITY

Number of collectors 20
 Collect area /m² 50
 Total collector area /m² 50

Checklist to be used when examining solar collectors*

Failure Detail	Con- densa- tion	Dirt or deposite	discolo- ration	Corro- sion	Outgas- sing	Flak- ing	Crack- ing	War- page	Leak- age	Break- age	Other degene- ration
Covers		1							4		
Absorber coating				2							
Absorber				2				3			
Insulation											
Enclosure											
Flashing											
Gasket									4		
Sealants									4		
Attachments											
Heat transfer media											
Remaining details											

*Number remarks for failure. Fill in NF for no failure, NA for not applicable and NC for not checked.

Remarks

Number (see checklist)

Description:

Potential cause:

Possible remedy to avoid failure during production and to mend it on the operating collector:

1. Since the system is located near a road with heavy traffic, there were soot and dust outside the covers.
2. The galvanized absorbers were to a large extent covered with white rust, which had destroyed the selective coating.
3. 3 out of 20 absorbers bulged, so they almost touched the inner glass cover.
One absorber curved in.
4. The original tightening material between collectors consisted of aluminum battens which were fastened with screws and silicone. After some time leakages were detected. Then aluminum foil with bitumen adhesive was adhered to the battens. But as the aluminum foil to a large extent was destroyed by snow loads there are still leakings present.

FLAT PLATE SOLAR COLLECTORS, RELIABILITY AND DURABILITY

G

Description of system, construction and failure of the solar collector discovered during examination.

Institute: National Institute for Testing,
Sweden

Author of report: K.O. Lagerkvist
H. Wennerholm

Date and hour for inspection: 1979-08-15

Location of system: Hörnefors, northern Sweden

Manufacturer of collector: Tekno Term Systems

Installation contractor:

Date of installation: 1978

Type of system: Swimmingpool

Heat transfer media: Water + glycol

Safety system: Drainage, antifreeze

Description of system, flow diagram:

Directions for filling in the sheet is attached at the back.

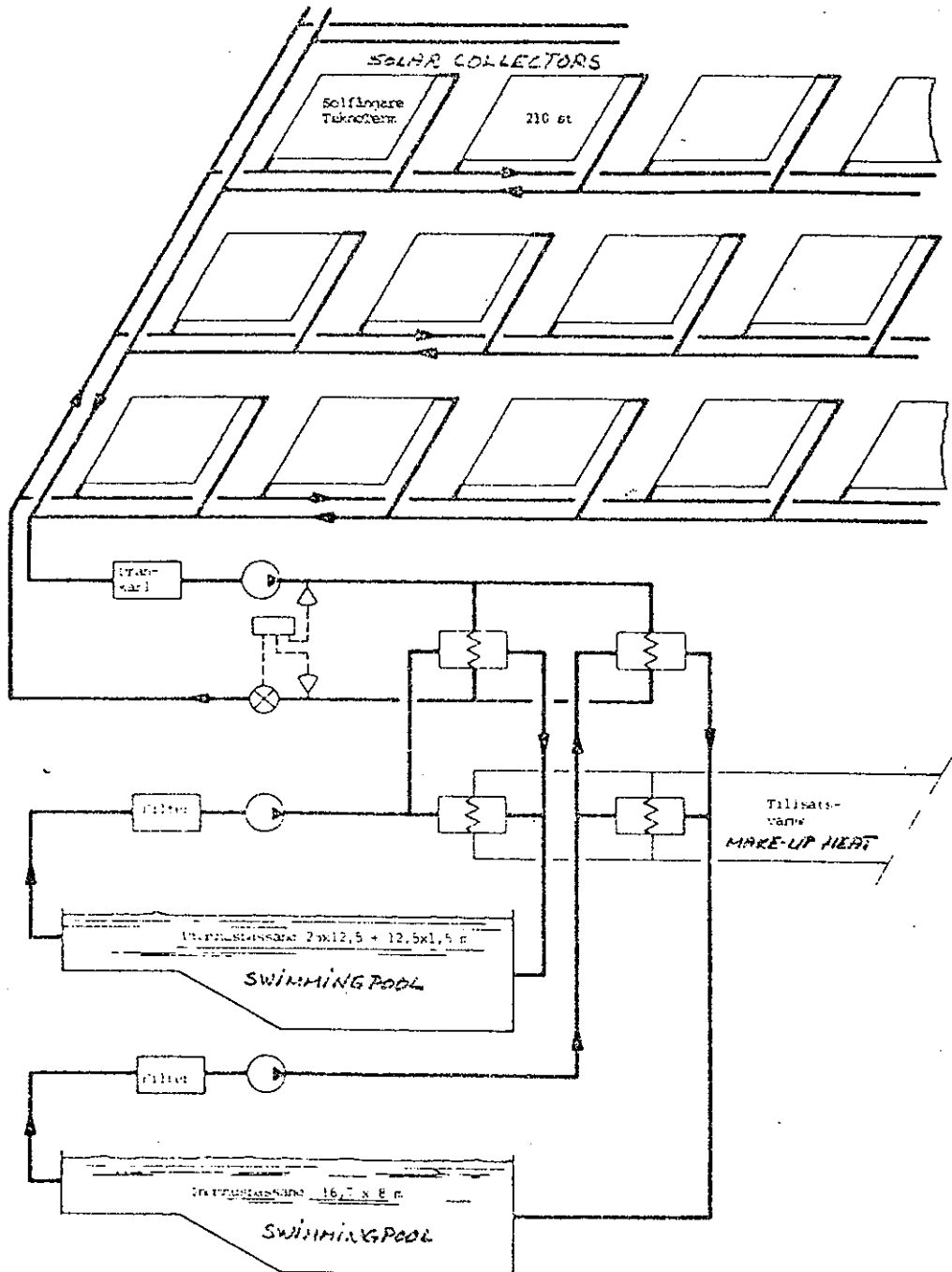

Component description (materials and manufacturer procedure):

Cover: Glass, 6 mm
Absorber coating: matt black paint
Absorber: steel
Insulation back: mineral wool
Insulation sides: none
Collector enclosure
back and edges: aluminum
Gaskets and sealants: polyacrylic
Flashing: aluminum
Attachments:
Other details:

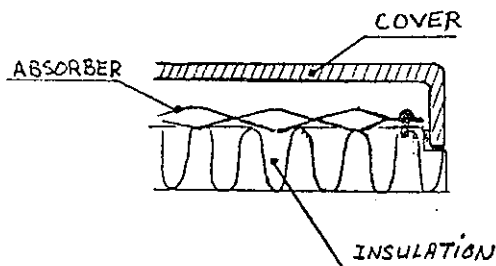
Description of collector:

Remarks

Number (see checklist)

Description:

Potential cause:

Possible remedy to avoid failure during production
and to mend it on the operating collector:

1. No condensation was observed at the time for inspection. Traces of water that had drained away was observed on some absorbers.
2. The absorbers are black painted, but here and there the primer show through.
3. Some corrosion in patches
4. Most aluminum battens at the short sides had come unstuck, because the glue used is not weather-proof.

Address: _____

Number of collectors 210

Collector area/m² 1

Total collector area/m² 210 FLAT PLATE SOLAR COLLECTOR, RELIABILITY AND DURABILITY

Checklist to be used when examining solar collectors*

Failure Detail	Con- densa- tion	Dirt or deposite	discolo- ration	Corro- sion	Outgas- sing	Flak- ing	Crack- ing	War- page	Leak- age	Break- age	Other degene- ration
Covers	1										
Absorber coating			2								
Absorber				3							
Insulation											
Enclosure									4		
Flashing											
Gasket											
Sealants											4
Attachments											
Heat transfer media											
Remaining details											

*Number remarks for failure. Fill in NF for no failure, NA for not applicable and NC for not checked.

FLAT PLATE SOLAR COLLECTORS, RELIABILITY AND DURABILITY

Description of system, construction and failure of the solar collector discovered during examination.

Institute: Thermal Insulation Laboratory, Technical University of Denmark, DTH, Byg. 118, 2800 Lyngby

Author of report: Peter Kjaerboe

Date and hour for inspection: April 3, 1979 at 9 a.m.

Location of system: "Zero-Energy House" Lyngby, Denmark, Lat. N 55,60, 12 km north of Copenhagen.
 Manufacturer of collector:

Thermal Insulation Laboratory

Installation contractor: The same

Date of installation: March 1975

Type of system: Residential and domestic hot water heating

Heat transfer media: Water, ELEMENTIN (prevent corrosion).

Safety system: The collectors are drained when difference temp. negative. If storage temp. over 96°C the circulation pump works cont.

Description of system, flow diagram:

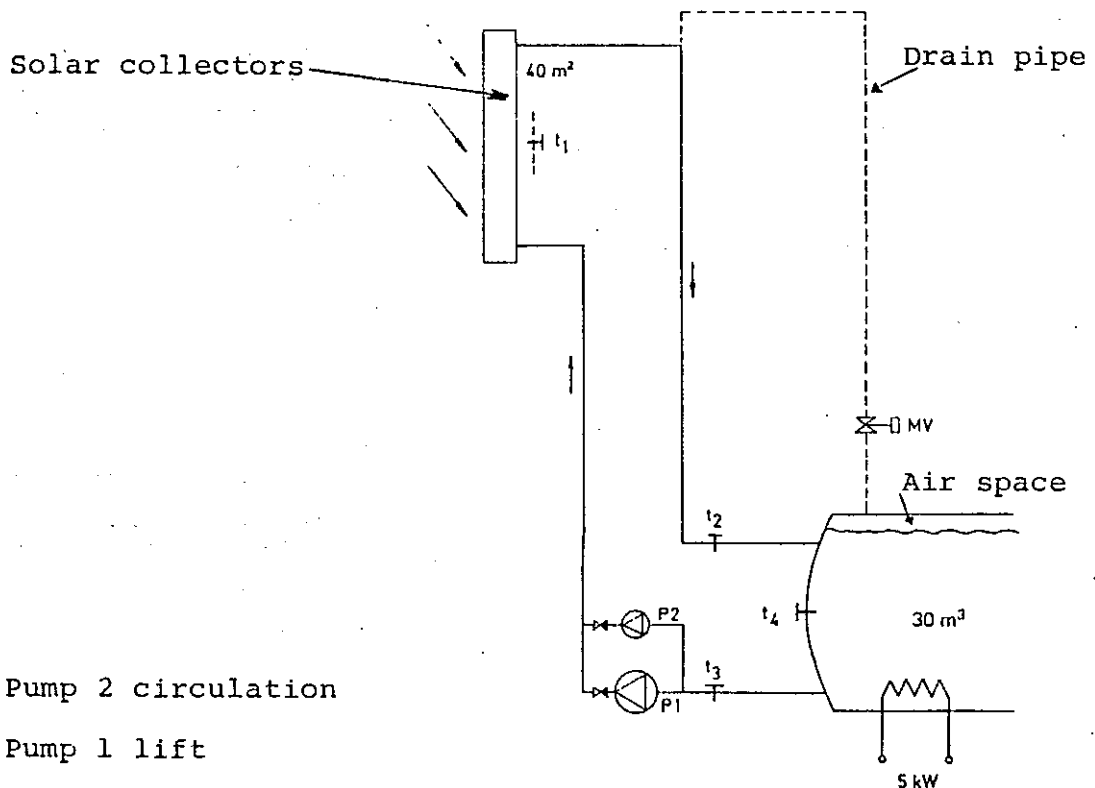

Directions for filling in the sheet is attached at the back.

Component description (materials and manufacturer procedure):

Cover: Two layer glass (Thermopane); 5+5mm thick.

Absorber coating: Black paint

Absorber: Electroalvanized steel

Insulation back Mineral wool, 250 mm

Insulation sides: Mineral wool, 100 mm

Collector enclosure Plywood 12mm

back and edges:

Gaskets and sealants: Silicone "Rhodosit"

Flashing: Integrated in an atrium

Attachments: Integrated in an atrium

Other details: (Reflector) Plastic sheet 0,09 mm thick, white.

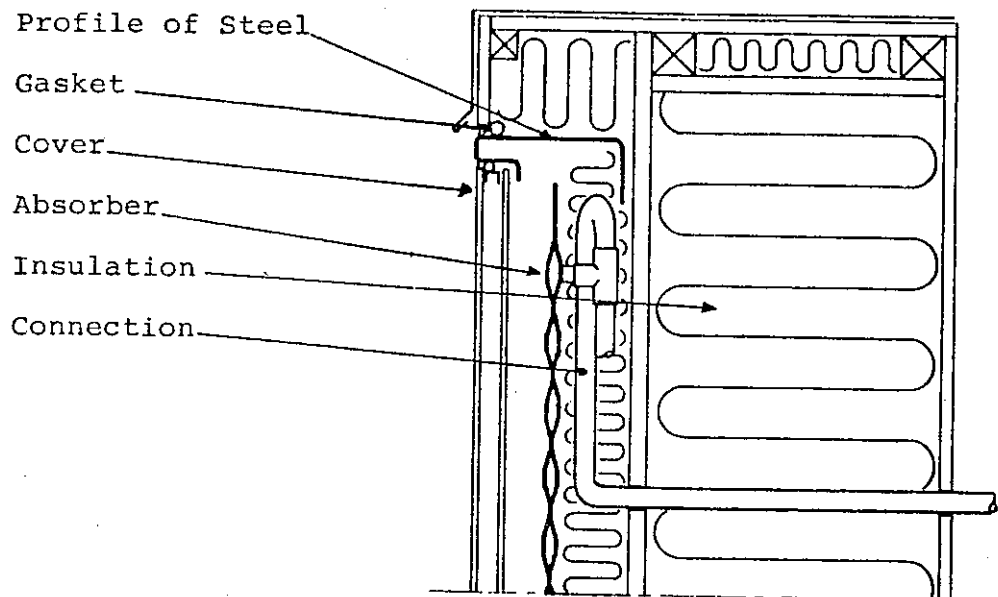
Description of collector:

Remarks

Number (see checklist)

Description:

Potential cause:

Possible remedy to avoid failure during production
and to mend it on the operating collector:

1. Condensation, dirt and leakage.

Water had condensated on the inside of the outer pane while the outer pane has the lowest temperature. Condensate was only found on the panes which were cracked causing leakage on 20 percent of the area, condensate was visible. Dirt was found as a very thin layer outside the pane on half of the area, probably because the collectors are vertically mounted, rain will not wash effectively.

2. Outgassing.

Probably some component from insulation or from sealants has condensated on a very small area, 0.3%. Fig. 2. This could not be called a failure but if it were, one has to choose materials carefully.

3. Cracking and breakage.

Four out of 32 panes were broken, and pieces had fallen down inside. Another five were only cracked, only inner panes. Fig. 3 and 4. The solar collector was exposed to stagnation at high temperatures during the installation period which was very sunny. The thermopanes used were designed in different ways with respect to ventilation of the airspace. It was strange to see that it was only the ones with modifications which cracked. The reason for cracking of the inner panes is the temperature difference between the middle and the edge of the pane. The edges of the inner pane function here as a "heat bridge".

4. Corrosion and flaking on attachments. Soldered joinings, not carefully cleaned from solder water, were beginning to corrode and absorber coating was flaking. Fig. 5. Could be repaired while cleaning and repainting.

5. Reflector flaking and cracking.

The reflector has been degraded due to normal weather conditions but the exact reason is unknown.

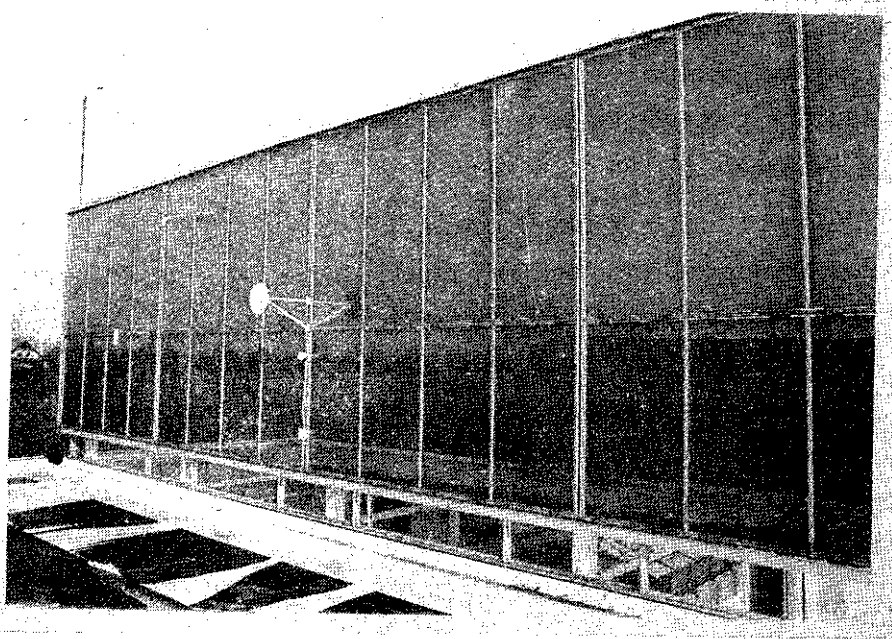

Fig. 1. Cracked glass and some condensate between panes. Reflector on roof, in front of picture, is broken.



Fig. 2 Outgassing from insulation or from sealant.

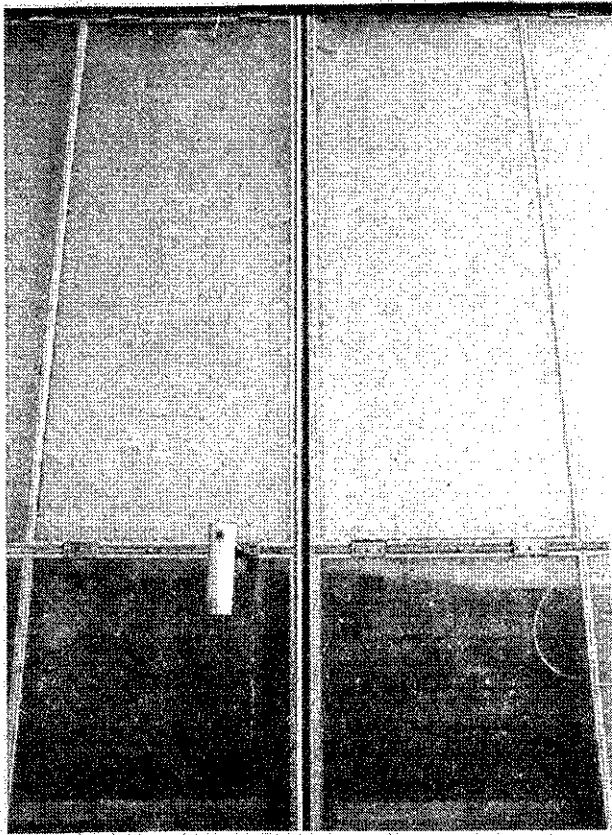

Fig. 3. Breakage of glass-pane

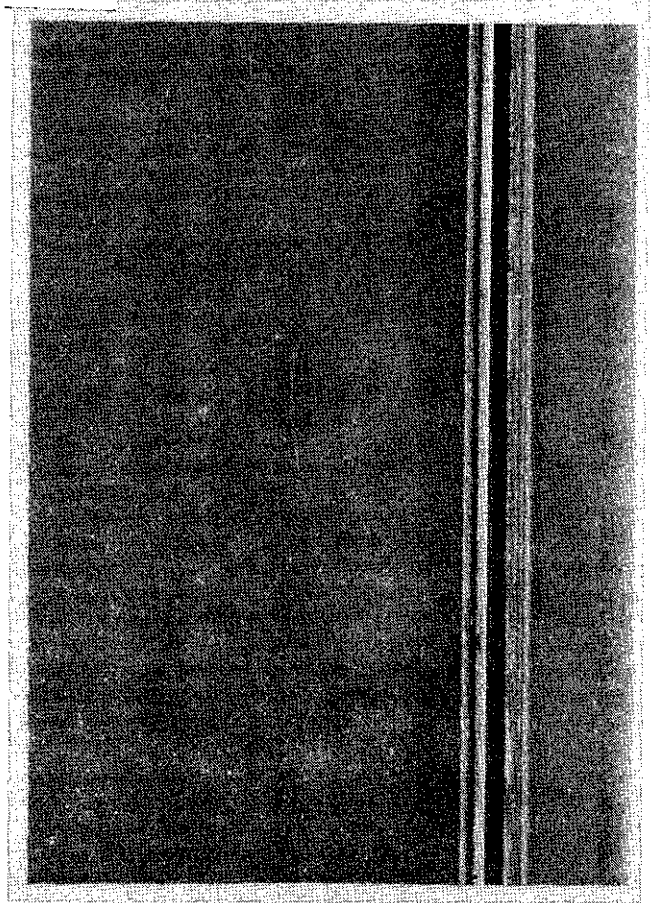

Fig. 4. Crack in glass probably beginning in the frame.



Fig. 5. Corrosion on attachment.

FLAT PLATE SOLAR COLLECTORS RELIABILITY AND DURABILITY

DESCRIPTION OF SYSTEM, CONSTRUCTION AND FAILURE OF THE SOLAR COLLECTOR, DISCOVERED DURING EXAMINATION.

Institute: Thermal Insulation Laboratory; building 118
Technical University of Denmark
2800 Lyngby, Denmark

Author of report: Peder Vejsig Pedersen

Date and hour for inspection: 15/8, h. 14.00 Cloudy weather

Location of system: Greve near Copenhagen

Manufacturer of collector: Eversol

Installation contractor: Private firm

Date of installation: January 1978

Type of system: Combined heating and domestic hot water system. The solar system is built as a demonstration project and was monitored for two years.

Total number of collector panels inspected: 30 collectors of = 1.68 m².

Heat transfer medium: Water/etyleneglycol + additives. 1 liter/m² minute.

Safety system: If higher temperatures than 85 °C are reached in the storage tank it is cooled during the following night. 30% ethylene glycol is used to prevent freezing.

DESCRIPTION OF SYSTEM, FLOW DIAGRAM, PICTURE OF COLLECTOR:

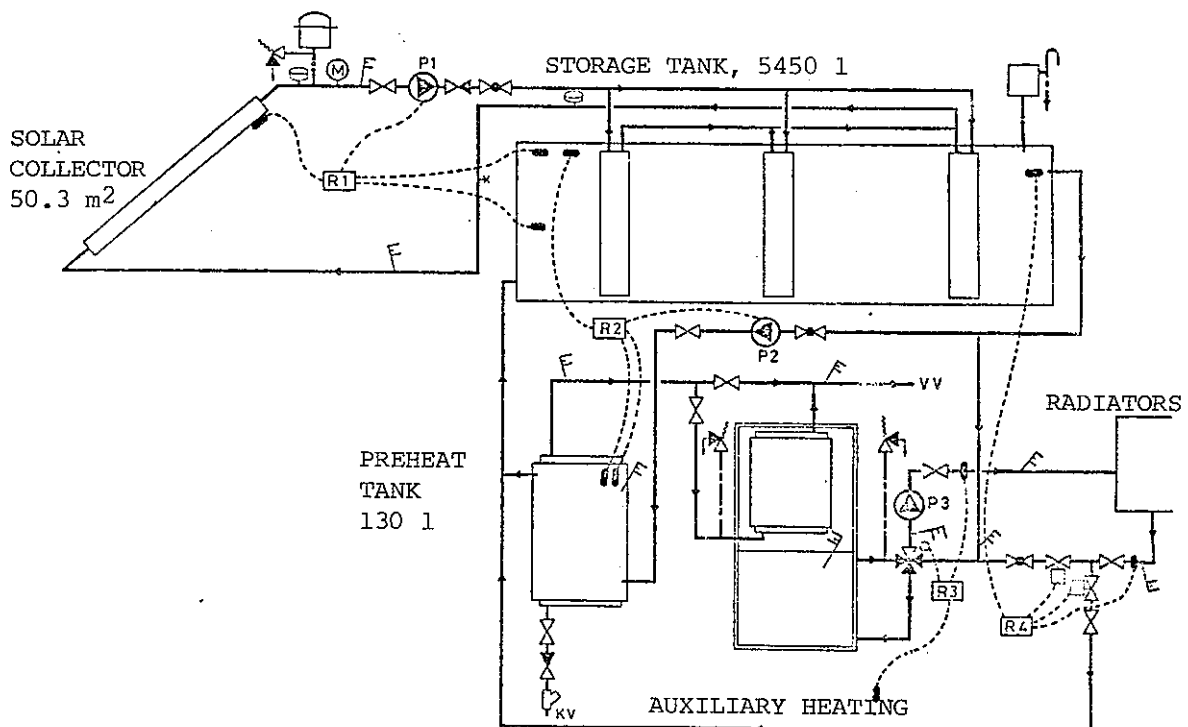

FLAT PLATE SOLAR COLLECTORS RELIABILITY AND DURABILITY

DESCRIPTION OF SYSTEM, FLOW DIAGRAM, PICTURE OF COLLECTOR.

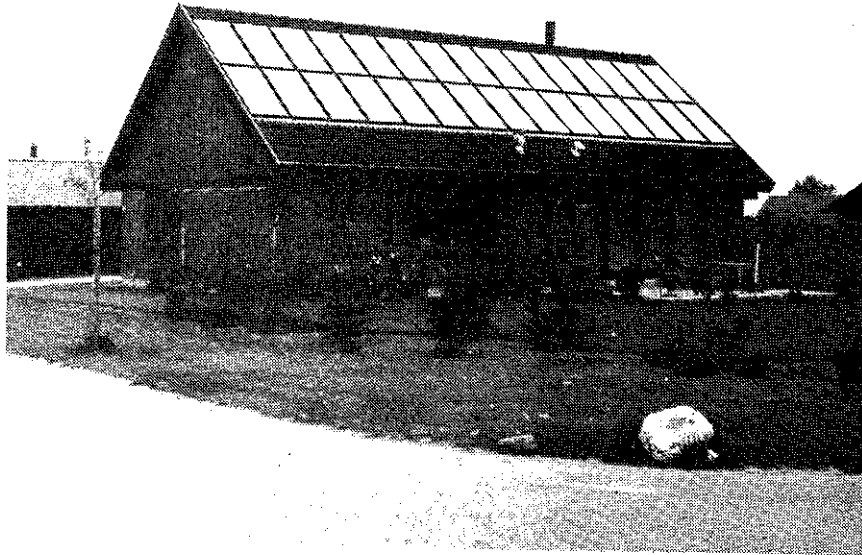

50.3 m² effective collector area on a standard house in Greve.
Tilt 38° and orientation 30° to west from south.

DESCRIPTION OF COLLECTOR.

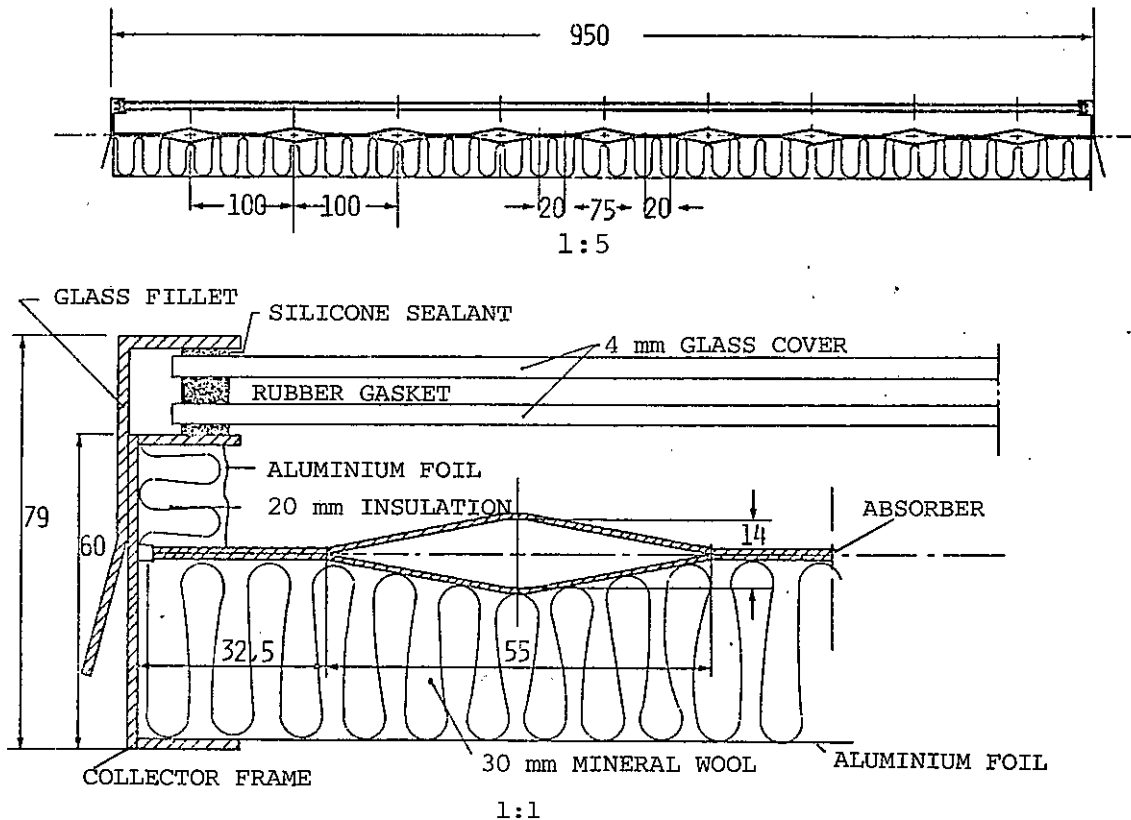

FLAT PLATE SOLAR COLLECTORS RELIABILITY AND DURABILITY

3

COMPONENT DESCRIPTION (materials and manufacture procedure) :

Cover: Two layers of glass, 4 mm, the spacing between the layers is 5 mm.

Absorber coating: Matt black paint

Absorber: Two steel plates with integrated fluid channels. See previous page.

Insulation back: 30 mm mineralwool with aluminium foil glued on the backside.

Insulation sides: 20 mm polystyrol covered with an aluminium foil.

Collector enclosure

back and edges: Glass fillet and collector sides are made of steel. No enclosure at the back, because the collector is meant to be built into the roof.

Gaskets and sealants: Butyl rubber gasket and silicone sealant.

Flashing: Zinc flashing of each collector.

Attachments: Angle iron mounted to rafters.

Other details:

NUMBER THE FAILURES FOUND DURING THE INSPECTION:

1. Condensation and dirt on the outer glass cover.
2. Breakage of cover.
3. Insufficient insulation at the back of the collectors and a very small spacing between the two glass covers mean low thermal efficiency during winter operation.
4. The edges of the steel enclosure at the bottom of the collectors have been causing rain leakage and prevent snow from sliding off the collectors.
5. The visible part of the silicone sealant is more or less dissolved, and parts of it are seen on the collector covers.

FLAT PLATE SOLAR COLLECTORS RELIABILITY AND DURABILITY

4

REMARKS ON THE FAILURES.

Numbers refer to the list on page 3.

Description:

Potential cause:

How severe is the failure:

*Possible remedy to avoid failures during production
and to mend it on the operating collector:*

1. Condensation and dirt on the outer glass cover of the collectors

Condensation on the inside of the outer glass was seen in some of the collectors. It was limited to a narrow band at the bottom of the covers.

The outer glass cover of the collectors was very dirty (see fig. 1), especially at the bottom of the cover near the steel edge of the glass fillet. The dirt might come from the chimney. And a sticky cover-surface because of dissolved sealant seems to be accumulating it.

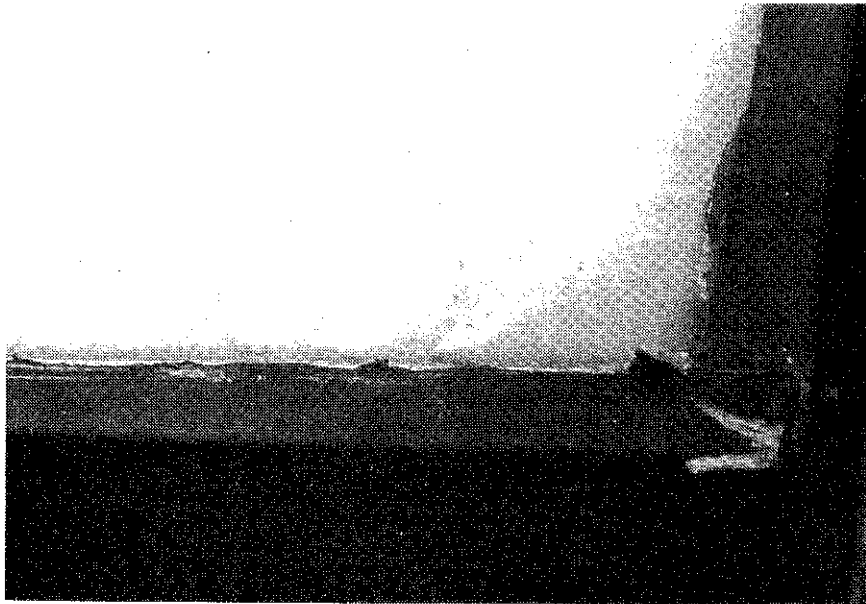

Fig. 1. There was a lot of dirt, especially at the lower part of the collectors.

FLAT PLATE SOLAR COLLECTORS RELIABILITY AND DURABILITY

4

REMARKS ON THE FAILURES.

Numbers refer to the list on page 3.

Description:

Potential cause:

How severe is the failure:

*Possible remedy to avoid failures during production
and to mend it on the operating collector:*

2. Breakage of glass cover

One of the covers broke during the repair of the collector leakage mentioned in item 4. (see fig. 2)

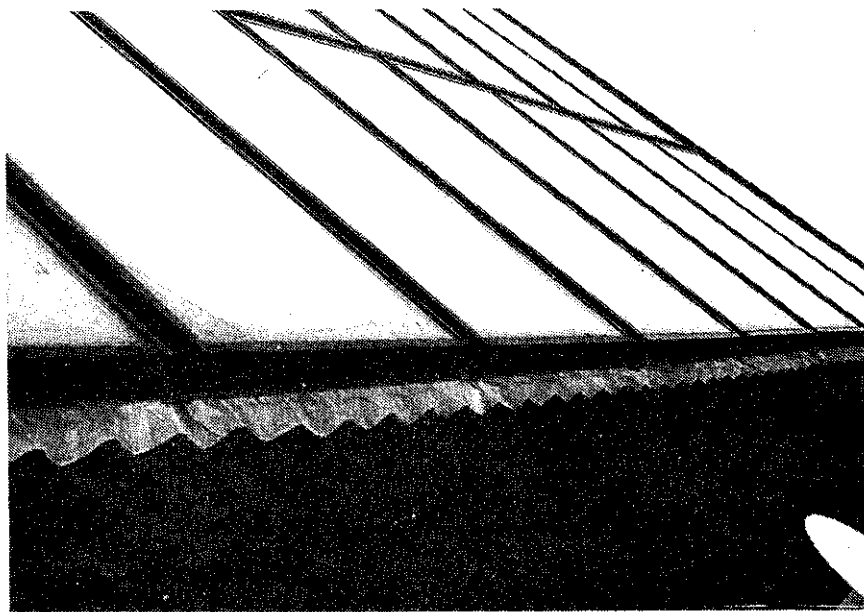

Fig. 2. One of the outer glass covers was broken in the corner.

The inner glass cover of two collectors once broke during stagnation because of pump defect. This is now repaired.

3. Insufficient insulation at the back of the collectors and a very small spacing between the two glass covers mean low thermal efficiency during winter operation.

There is only an insulation at the back of the collectors of 30 mm mineral wool which is covered with an aluminium foil.

FLAT PLATE SOLAR COLLECTORS RELIABILITY AND DURABILITY

4

REMARKS ON THE FAILURES.

Numbers refer to the list on page 3.

Description:

Potential cause:

How severe is the failure:

Possible remedy to avoid failures during production
and to mend it on the operating collector:

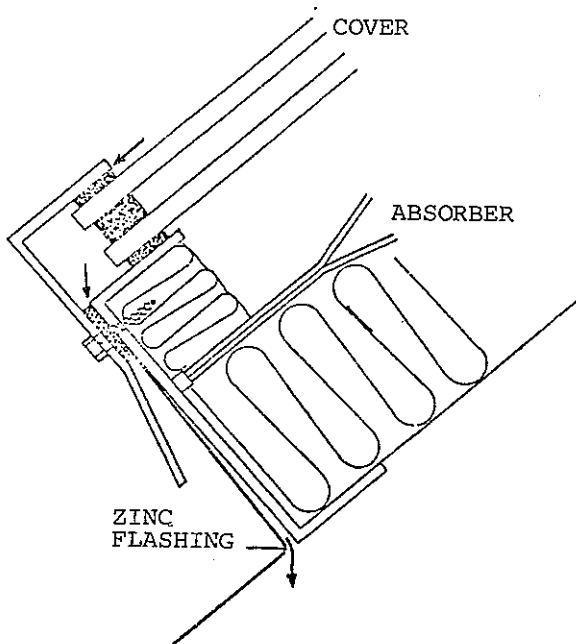

Fig. 3.

At first rain entered the collectors through the silicone sealant between the glass and the steel glass fillet at the bottom of the collectors.

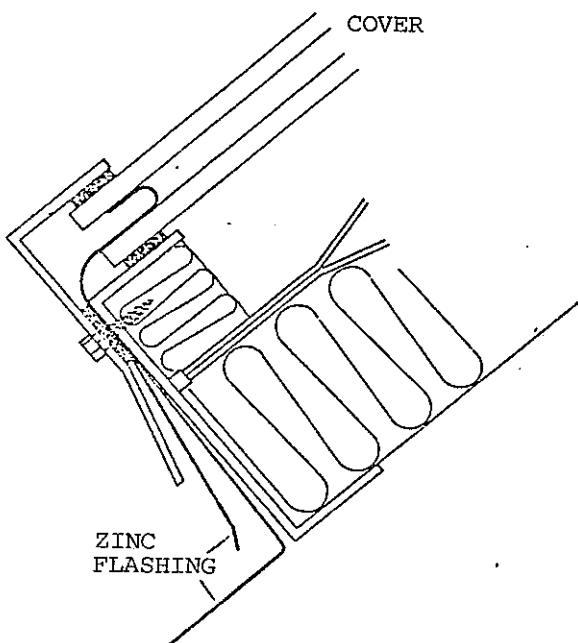

Fig. 4.

This problem was solved by removing the butyl rubber gasket and introducing an extra zinc flashing into the bottom of the collectors.

FLAT PLATE SOLAR COLLECTORS RELIABILITY AND DURABILITY

4

REMARKS ON THE FAILURES.

Numbers refer to the list on page 3.

Description:

Potential cause:

How severe is the failure:

Possible remedy to avoid failures during production
and to mend it on the operating collector:

The collectors are integrated in the roof and the backside of the collectors is exposed to the climate conditions of an uninsulated ceiling with ambient temperatures. It is possible to get a finger in from behind the collectors to touch the edges of the absorber. The spacing between the two glass covers of the collectors is only 5 mm (recent calculations show that it should not be less than 10 mm for efficiency reasons). The combination of insufficient backside insulation and spacing between the glass covers is expected to give a very low efficiency of the collectors at high values of $\Delta T =$ (temperature of absorber minus temperature of ambient).

This combined with the fact that the storage tank is placed in a room with temperatures near ambient means that even sunny winterdays will often not be able to produce tank temperatures high enough to be used for heating.

4. The edges of the steel enclosure at the bottom of the collectors have been causing rain leakage and prevent snow from sliding off the collector.

The silicone sealant between the glass cover and the edge of the steel glass fillet at the bottom of the collectors was found not to be raintight after a period of operation, as shown in fig. 3. This was the reason for rain leakage into the collectors and from the collectors into the house when it was raining. The best solution to this problem could be a different collector construction where the upper glass cover would have no steel frame at the bottom of the collector so that water could run off the collector. In Greve the collectors were repaired by introducing an extra zinc flashing into the collector, as shown in fig. 3 and 4. This seems to be

FLAT PLATE SOLAR COLLECTORS
RELIABILITY AND DURABILITY

4

REMARKS ON THE FAILURES.

Numbers refer to the list on page 3.

Description:

Potential cause:

How severe is the failure:

Possible remedy to avoid failures during production
and to mend it on the operating collector:

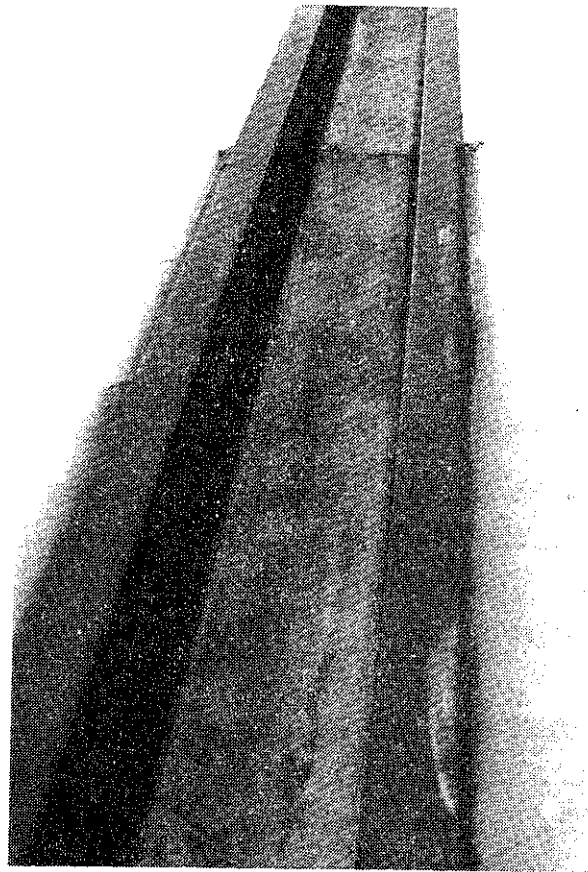

Fig. 5. Some of the silicone sealant are dissolved and parts of it are seen on different places of the glass cover.

FLAT PLATE SOLAR COLLECTORS RELIABILITY AND DURABILITY

4

REMARKS ON THE FAILURES.

Numbers refer to the list on page 3.

Description:

Potential cause:

How severe is the failure:

Possible remedy to avoid failures during production
and to mend it on the operating collector:

a good and raintight solution.

A minor leak in the collector flashing has also been observed at heavy rain. This leak has not been repaired since the exact position of it has not been found. It is a general problem with this collector construction that all 30 prefabricated elements are enclosed in separate flashings. This means a lot of work when installing the collectors and many possibilities for leaks.

The collectors were guaranteed for five years, but because of some doubt of who was to take the initiative to repair the collectors from rain leakage, it took 4 months before this was done. This problem could be prevented by introducing a time limit for the manufacturer to repair defects.

The edges of the steel glass fillet at the bottom of the collectors were also found to be a problem during winter. They often prevented snow from sliding off the collectors even on sunny days.

5. The visible part of the silicone sealant is more or less dissolved and parts of it are seen on the collector covers.

As shown in fig. 5 some of the visible parts of the silicone sealant are more or less dissolved. Parts of it are seen in different spots of the glass covers. This could be the reason for the sticky cover surface mentioned in item 1.

FLAT PLATE SOLAR COLLECTORS, RELIABILITY AND DURABILITY

Description of system, construction and failure of the solar collector discovered during examination. **J**

Institute: Thermal Insulation Laboratory, Building 118
Technical University of Denmark, 2800 Lyngby, Denmark

Author of report: Peder Vejsig Pedersen

Date and hour for inspection: March 4, 1980, 11.00 a.m.
clear sky

Location of system: Gentofte (see fig. 1)

Manufacturer of collector: Danish Solar Heating K/S

Installation contractor: Private firm, Erik Petersen

Date of installation: January - May 1978 (collector in April)

Type of system: combined heating and domestic hot water system

Heat transfer media: water/ethylene glucol (30%)

Safety system: Pump in prim. circuit is automatically operated for cooling during night if storage temperature exceeds 85 °C.

Description of system, flow diagram:

28 m² collector.

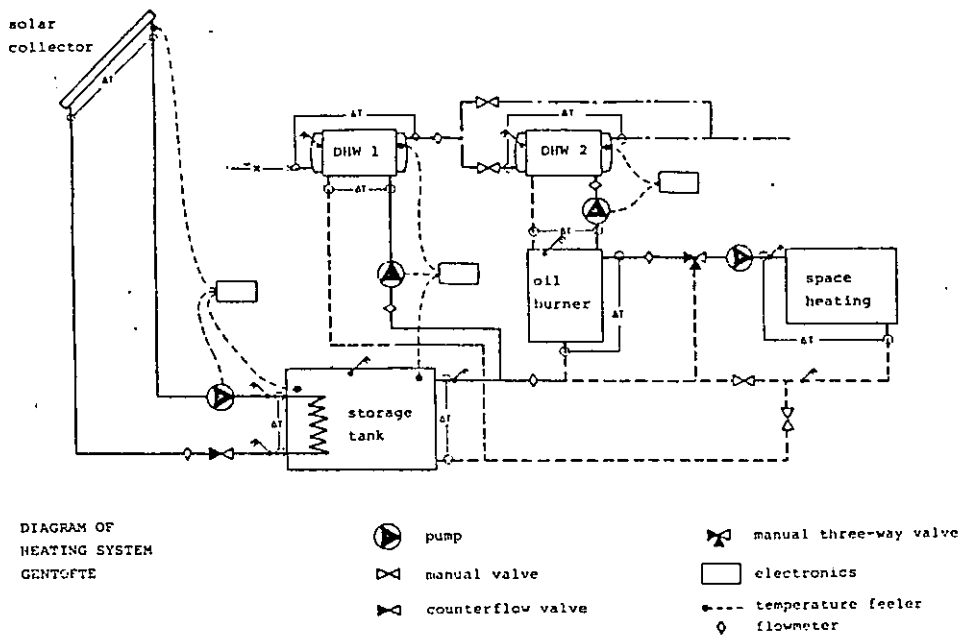

Directions for filling in the sheet is attached at the back.

Component description (materials and manufacturer procedure):

Cover: two layers of glass, 4 and 5 mm.

Absorber coating: black paint (alkyd)

Absorber: aluminium plate, steel tubes 16/13

Insulation back mineral wool, 75 mm

Insulation sides: none, except frame of wood

Collector enclosure

back and edges: compregnated wood frame, galvanized angle iron frame on top, asbestos cement at the back (see below)

Gaskets and sealants: rubber packing gasket with silicone

Flashing: steel plate - and lead flashing

Attachments: angle iron mounted to rafters

Other details:

Description of collector:

(see also fig. 2)

5 mm reflexfree Albarino glass

4 mm glass

aluminium absorber with black paint

moulding pressed aluminium

16/13

steel tubes

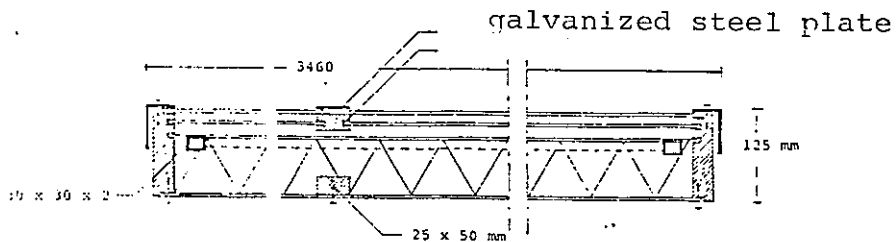
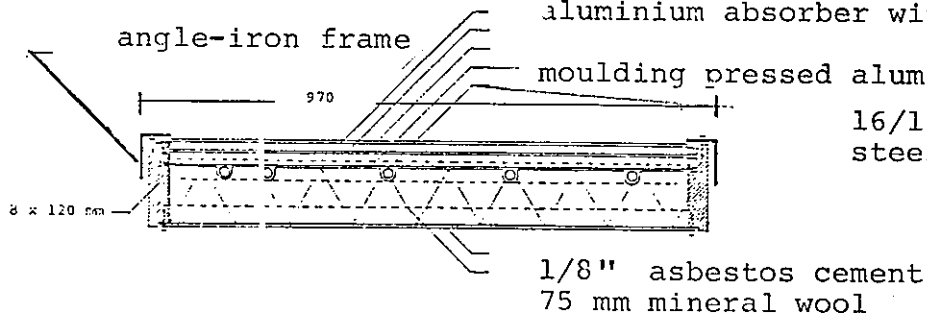

Remarks

Number (see checklist)

Description:

Potential cause:

Possible remedy to avoid failure during production
and to mend it on the operating collector:

- 1, 2, Condensation, white deposit and outgassing on the
3 outer glass cover

Nearly all of the solar collectors had condensation on the inside of the outer glass cover. About half of the collector area was with condensation. Big drops which could drip at the lower glass cover were seen (see fig. 3 and 4).

There was also a lot of corny white deposit on large areas of the outer glass cover (see fig. 5).

The problem with the white deposit was also seen at collectors of the same type, which had been placed outside at the Thermal Insulation Laboratory test area.

The problem with the white deposit in the collector at the test area did not arise in the summer, but only in the wintertime, most of it came late in December.

We thought that the reason for such deposit could be that a wood frame was part of the collector enclosure. (This is the main difference of this collector compared to the rest of the collectors at the test area which had not had problems with white deposit). We made a chemical analysis of the white deposit, which proved to be resin from the wood frame. Perhaps it has been dissolved in the air humidity and was brought to the glass by condensation. This would also be an explanation of why there is no such deposit at the inner glass cover. The wood frame had also become a bit green looking and seemed to be wet.

There are also outgassing products on the inside of the outer glass cover (a clear film), which we think is coming from the binding agent of the mineral wool. The flashing of the inner glass cover to the collector frame is not airtight, so this will not be able to stop the outgassing products.

- 4 Dirt at the outside of the glass cover

There was a lot of dirt on the outside of the glass cover. There is a chimney on the top of the roof, near the solar collector, so this might be where the dirt comes from. Horizontally there are many edges of 5 mm on the collector of the galvanized steel plate flashing where a lot of dirt is collected.

Remarks

Number (see checklist)

Description:

Potential cause:

Possible remedy to avoid failure during production
and to mend it on the operating collector:

5 Deposit on the absorber plate

A few brown sticky looking small deposits were observed on the absorber plate, which we also think was resin from the wood frame (see fig. 6). It was observed during the summer period that resin fluid was produced in the wood when there were high temperatures in the collector.

6 Rain leakage

There have been some minor rain leakages in the collector construction. The problem has been localized to the galvanized steel plate flashing. In fig. 7 you can see what we think might be the reason. The steel flashing rests on some screw heads of the collector. The installation contractor has now tried to improve the flashing, so now it should be rain tight.

7 Maintenance of the collectors

Three of the outer cover glasses were broken because of careless treatment of the collectors. The last time was when the contractor tried to solve the leakage problem through the flashing. It was very costly to repair the collectors because you have to remove all the collector flashing and lift the collector modules up just to change one glass cover. This is a good example of bad maintenance facilities of solar collectors.

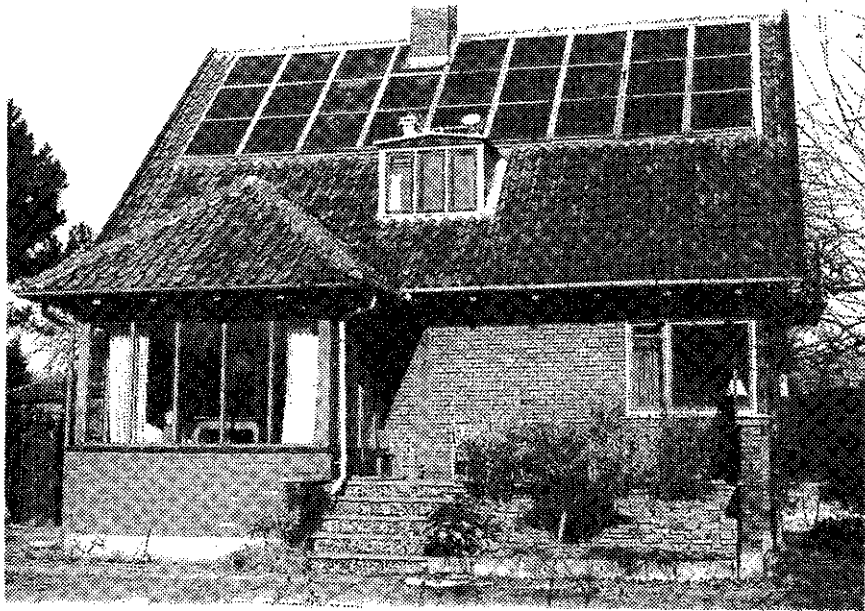

Fig. 1. Solar heating and domestic hot water system in Gentofte.

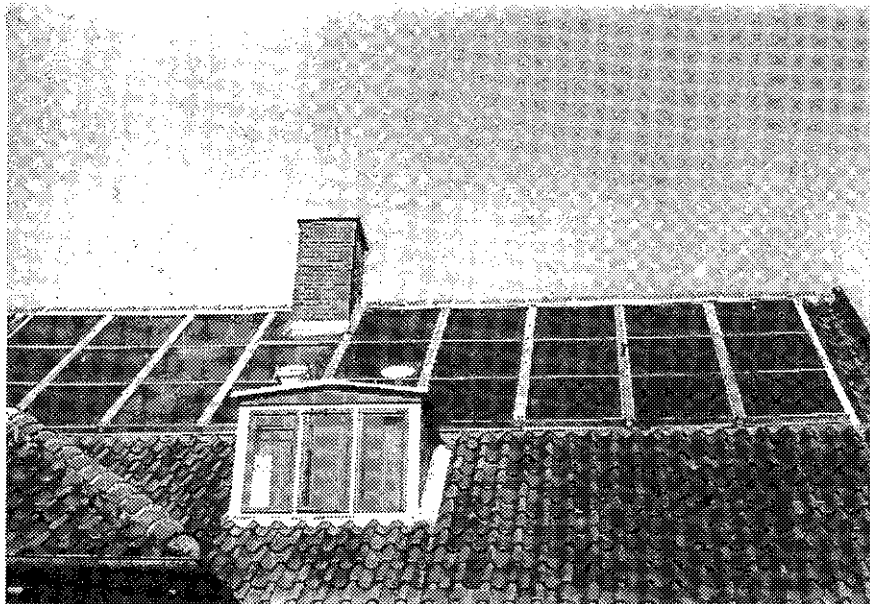

Fig. 2. The collector is built from collector modules, 28 m^2 in all.

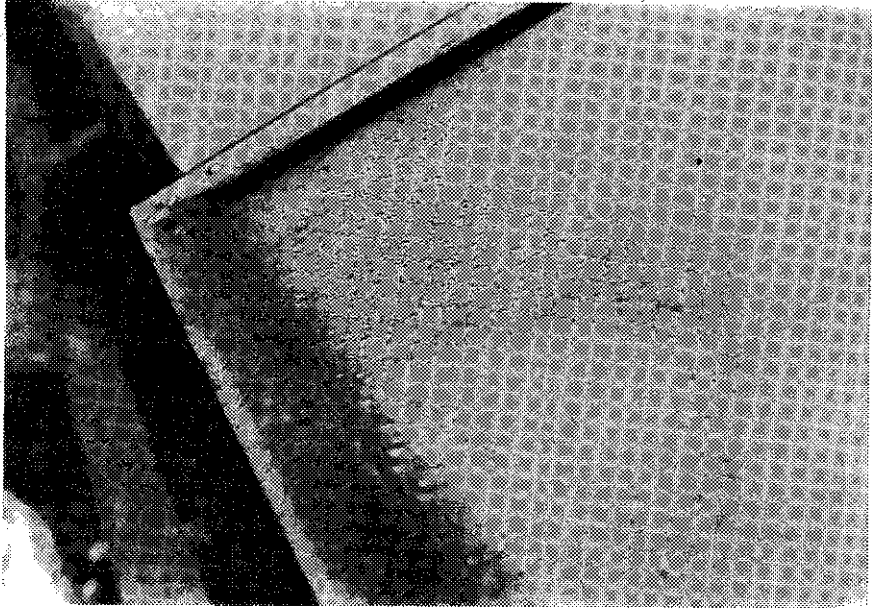

Fig. 3. Condensation in a collector of the same type which is used in Gentofte.

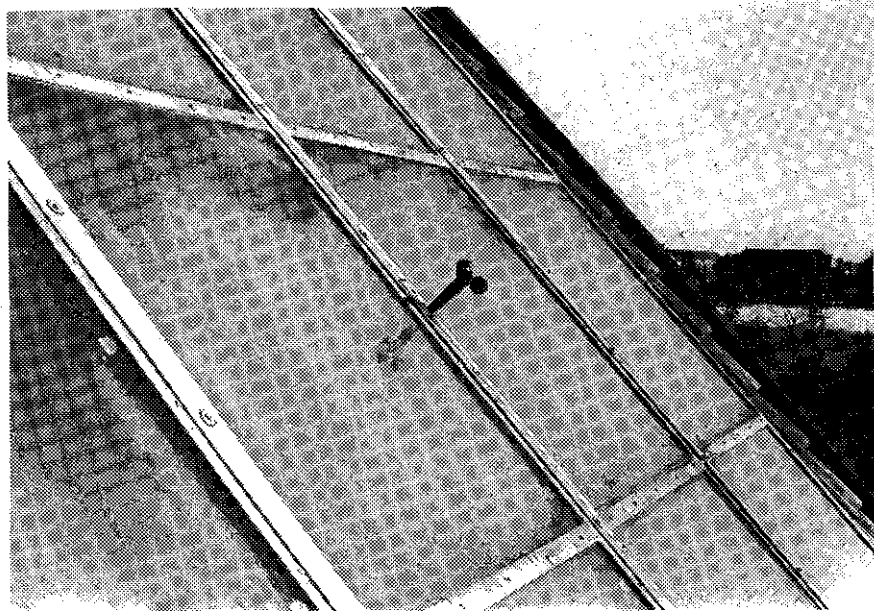

Fig. 4. Solar collectors with condensation.

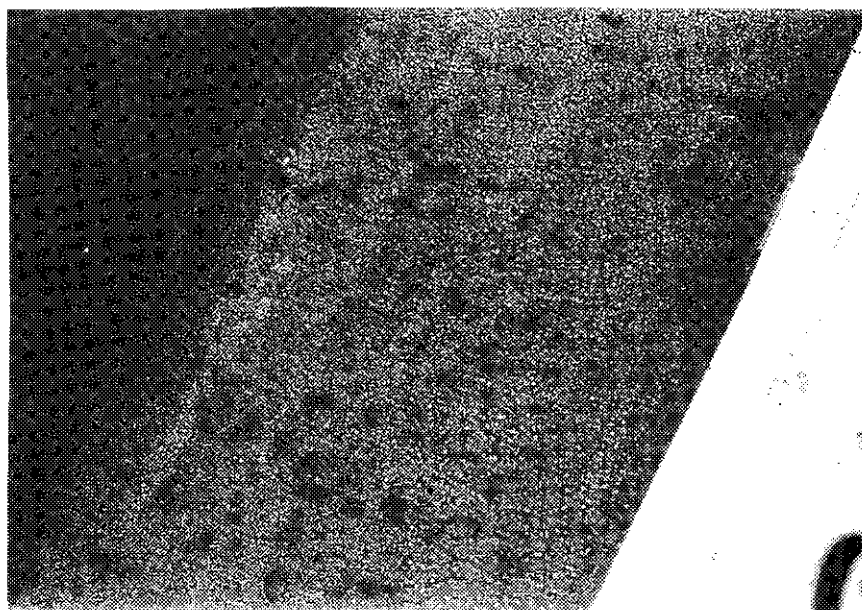

Fig. 5. Example of white deposit on the inside of the outer glass cover.

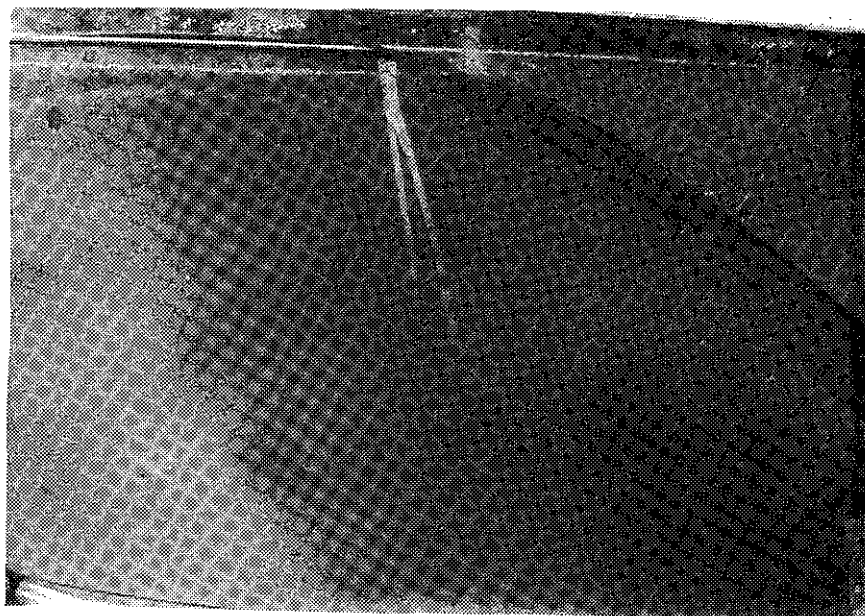

Fig. 6. Brown deposit on the absorber surface, and example of the outer glass cover which broke and was very expensive to change.

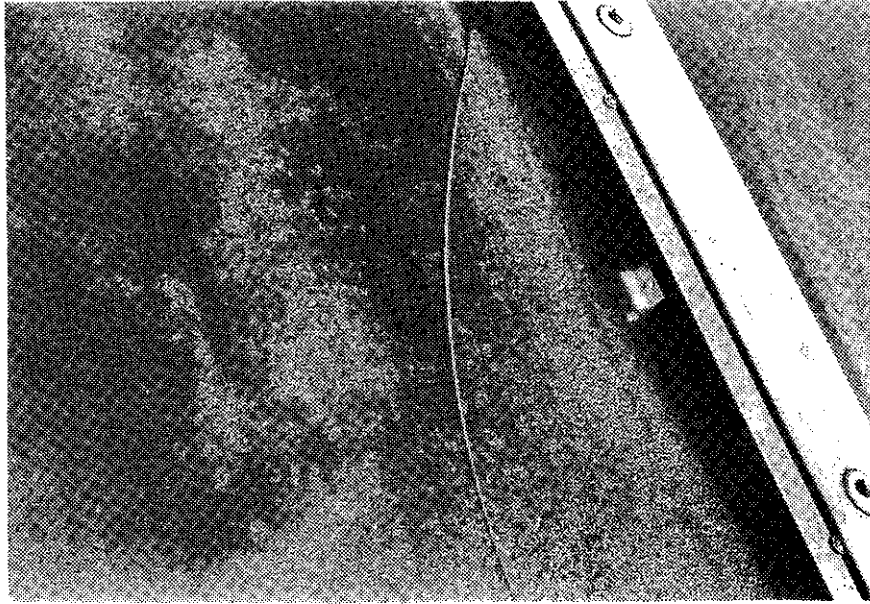

Fig. 7. Here you can see the galvanized steel plate flashing which rests on screw heads of the collector.

FLAT PLATE SOLAR COLLECTORS RELIABILITY AND DURABILITY

1
K

DESCRIPTION OF SYSTEM, CONSTRUCTION AND FAILURE OF THE SOLAR COLLECTOR, DISCOVERED DURING EXAMINATION.

Institute: Thermal Insulation Laboratory, building 118
 Technical University of Denmark
 2800 Lyngby, Denmark

Author of report:

Peder Vejsig Pedersen

Date and hour for inspection: 26/11-80, 14⁰⁰ clear sky, frost, it had been snowing earlier

Location of system: Valby near Copenhagen

Manufacturer of collector: Dansk Solvarme

Installation contractor: Site built by inhabitants

Date of installation: September 1977

Type of system: Domestic hot water system

Total number of collector panels inspected: 5 absorber plates with greenhouse

Heat transfer medium: cover, there are 14 m² of efficient collector area
 Water/ethyleneglycol + additives

Safety system: Ethyleneglycol is used to prevent freezing

DESCRIPTION OF SYSTEM, FLOW DIAGRAM, PICTURE OF COLLECTOR:



Solar heating system for domestic hot water in Valby

FLAT PLATE SOLAR COLLECTORS RELIABILITY AND DURABILITY

2

DESCRIPTION OF SYSTEM, FLOW DIAGRAM, PICTURE OF COLLECTOR.

SOLAR HEATING SYSTEM IN VALBY FOR DOMESTIC HOT WATER HEATING

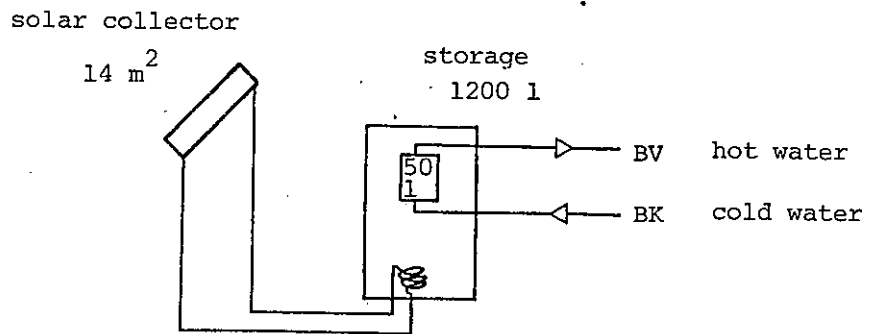

For 4-5 months in the summer time, the solar system alone takes care of the domestic hot water need. The rest of the year it preheats the domestic hot water. From August 1979 to August 1980 a calorimeter measured 2100 kWh of delivered solar energy from the system.

DESCRIPTION OF COLLECTOR.

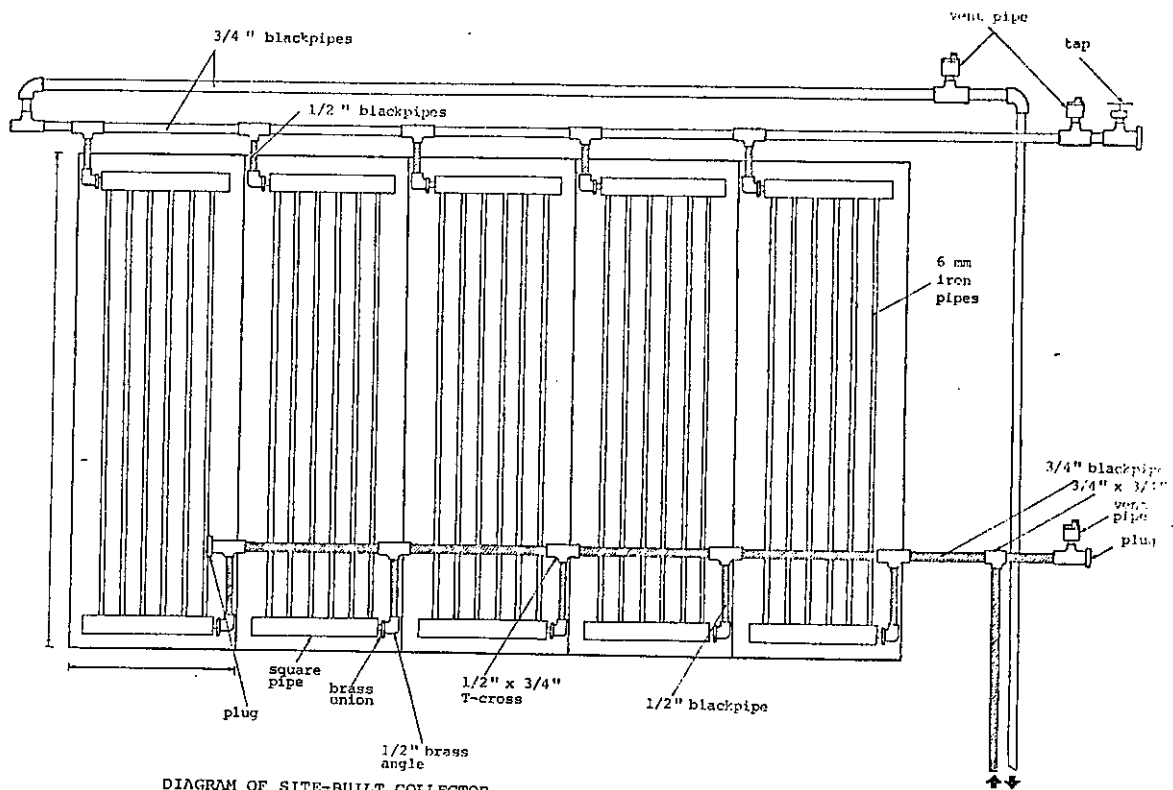

DIAGRAM OF SITE-BUILT COLLECTOR

FLAT PLATE SOLAR COLLECTORS RELIABILITY AND DURABILITY

3

COMPONENT DESCRIPTION (materials and manufacture procedure) :

Cover: 4 mm glass. The collector cover is built in the same way as is known from greenhouses. The glass is placed in aluminiumprofiles and have a 50 mm overlap. See fig. 1.

Absorber coating: black paint (alkyd)

Absorber: Two aluminium plates which are spotwelded around steel pipes.

Insulation back: 170 mm mineral wool, with a plastic vapour barrier in the middle.

Insulation sides: None, except a masonite plate and flashband flashing the three sides, and ridge putty at the bottom between glass and absorber, 50 mm.

Collector enclosure back and edges: The collector is built into the roof - site built. See fig. 1.

Gaskets and sealants: There is no sealant between glasses, which they overlap. In the aluminiumprofiles there is a rubber gasket.

Flashing: The two sides and the top of the collector is flashed with flashbands, while at the bottom the spacing between the

Attachments: glass cover and the absorber is filled with ridge putty (Ceny R-kit). The glass is lengthened with 50 mm at the bottom so that water can run off the collector.

Other details:

NUMBER THE FAILURES FOUND DURING THE INSPECTION:

1. Condensation on the inside of the glass cover.
2. The collector is curved in the horizontal plane.
3. Outgassing products at the inside of the glass cover.
4. The lowest glass cover to the left once slipped a few centimeters.
5. Dust on the absorber surface.
6. The putty between glass and absorber has become very brown.
7. The flashband flashing was leaking in the beginning.
8. A satisfactory humidity was measured in the 50 mm backside insulation.
9. An evaluation of the collector after 3 years of operation.

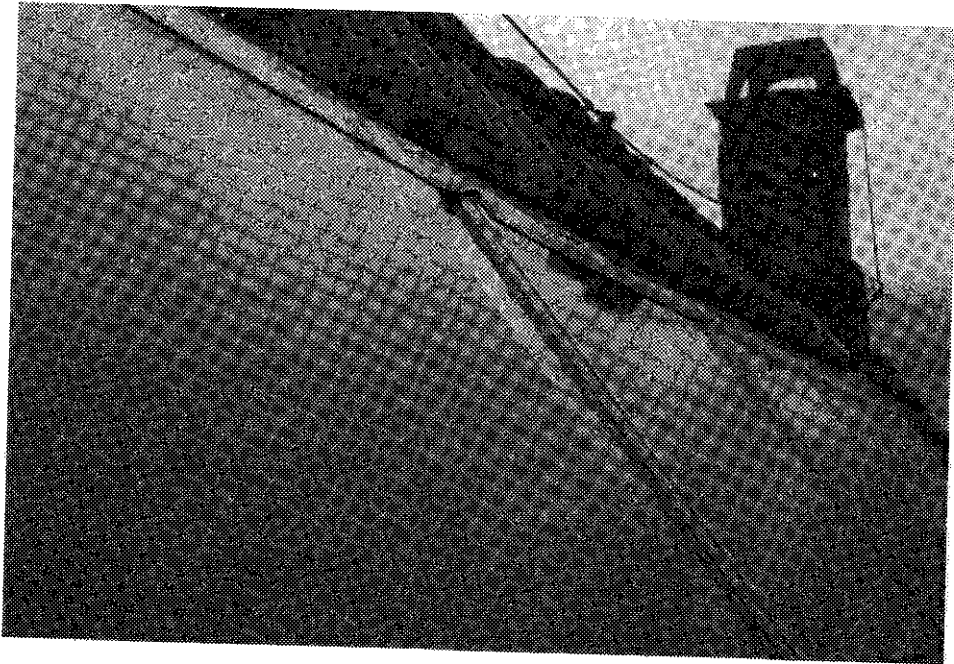

Fig. 2. The top of the collector.

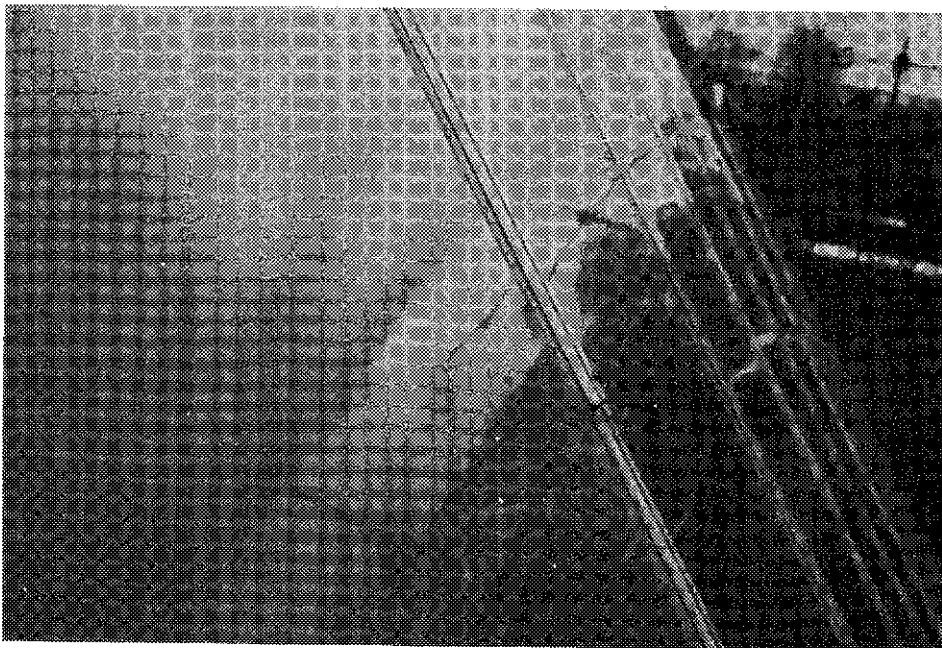

Fig. 3. The cover is made in the same way which is used in greenhouses. The glasses overlap each other.

DESCRIPTION OF COLLECTOR

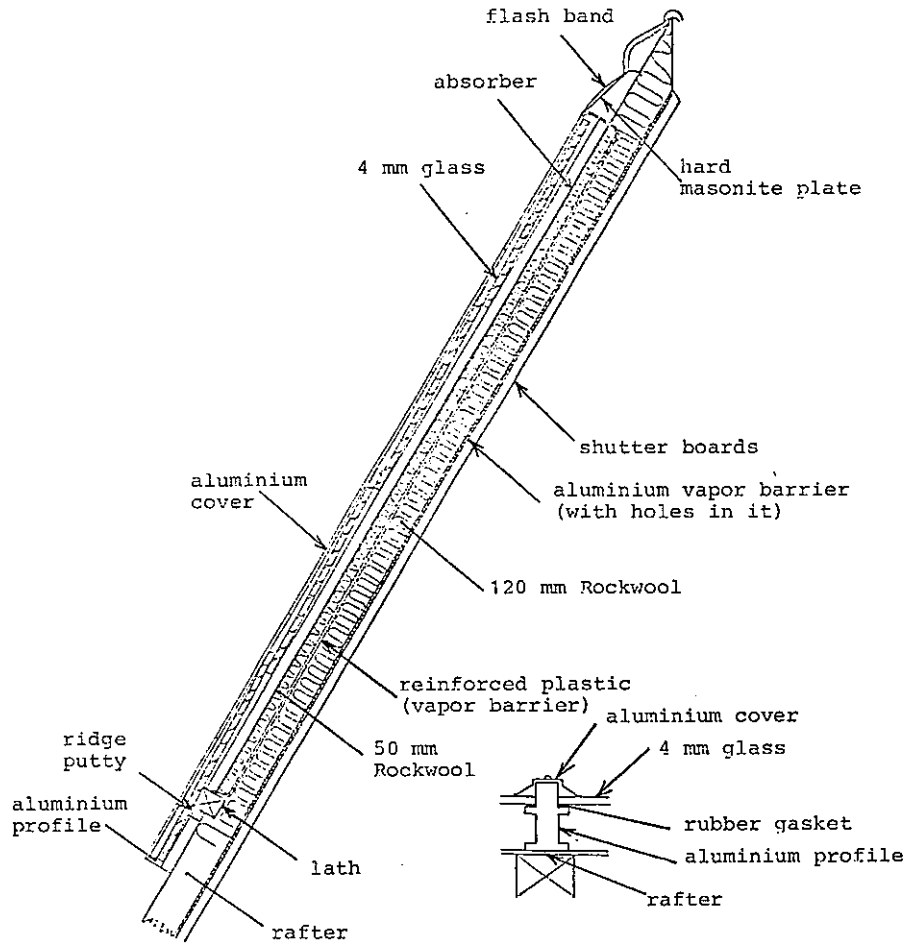

Fig. 1. CROSS SECTION OF THE SITE-BUILT SOLAR COLLECTOR
IN VALBY.

The drawing is made by one of the constructors of the solar collector after memory, note that spacing between glass and absorber is not correct in the figure

FLAT PLATE SOLAR COLLECTORS RELIABILITY AND DURABILITY

4

REMARKS ON THE FAILURES.

Numbers refer to the list on page 3.

Description:

Potential cause:

How severe is the failure:

*Possible remedy to avoid failures during production
and to mend it on the operating collector:*

1. Condensation on the inside of the glass cover

Especially at the top of the collector a lot of condensation was observed, see fig. 2 and 3. In one place a drop had run down on the cover. In the middle and at the bottom of the collector there was no condensation.

Condensation is very often seen in collectors at this time of the year. Even collectors with a very good ventilation often have difficulties in preventing heavy condensation. Under some circumstances heavy condensation can form drops which might drip down on the absorber. This might lead to corrosion of the absorber surface if this one has not got a durable surface treatment. In this case there was not observed any corrosion of the absorber surface, even though the collector was more than three years old.

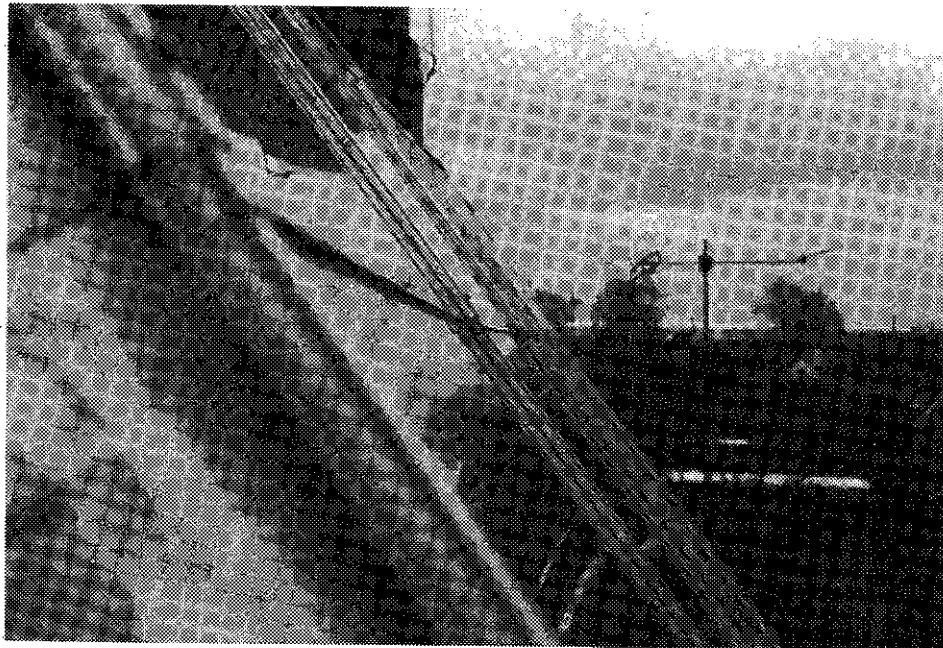

Fig. 4. The collector curved in the horizontal plane.

FLAT PLATE SOLAR COLLECTORS RELIABILITY AND DURABILITY

4 a

2. The collector curved in the horizontal plane

This is seen in fig. 4. The problem is only aesthetic, and the reason is a measurement error when the collector was constructed.

3. Outgassing products at the inside of the glass cover

The outgassing might come from the binder of the mineral wool, or from the ridge putty mentioned in item 6.

4. The lowest glass cover to the left once slipped a few centimeters.

This was because the two aluminium covers over the "greenhouse" aluminium profiles had loosened. The reason was that the slot in the aluminium profile was unsatisfactory, perhaps because wrong screws were used. It was very difficult to repair the collector. At last this was done by using a rope around the chimney. This is another example of maintenance problems of solar collectors.

5. Dust on the absorber surface

The flashing of the collector is not air tight at all. Dust must be ventilated into the collector from outside, some of it might come from the chimney.

6. The putty between the glass and the absorber has turned brown

According to Danish circumstances this solar collector is quite an old construction. Ridge putty was recommended by the manufacturer for sealing in the bottom of the collector between absorber and glazing. There is no sign that the putty has been a bad sealing, but it has changed colour into dark brown and is certainly exposed to higher temperatures than it is supposed to be. At the present moment, it is difficult to say for how many years it will function satisfactorily.

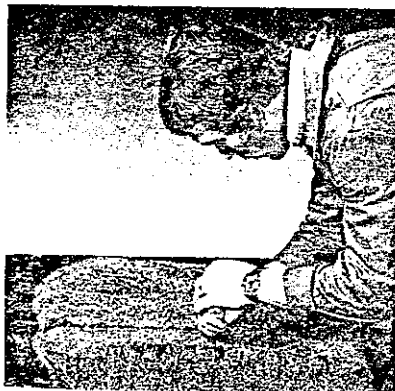

Fig. 5. The ridge putty product used in the bottom of the collector.

FLAT PLATE SOLAR COLLECTORS 4 b RELIABILITY AND DURABILITY

7. The flashband flashing was leaking in the beginning

Flashband (a product to make valleys with) was chosen as flashing because it was cheaper than lead flashing. Lead flashing is generally recommended for this kind of collector constructions. In the beginning the collector was leaking rainwater into the house because of the flashband. The leaks were repaired with more flasband and a sealing material. At last it was raintight, and since then there have not been any problems.

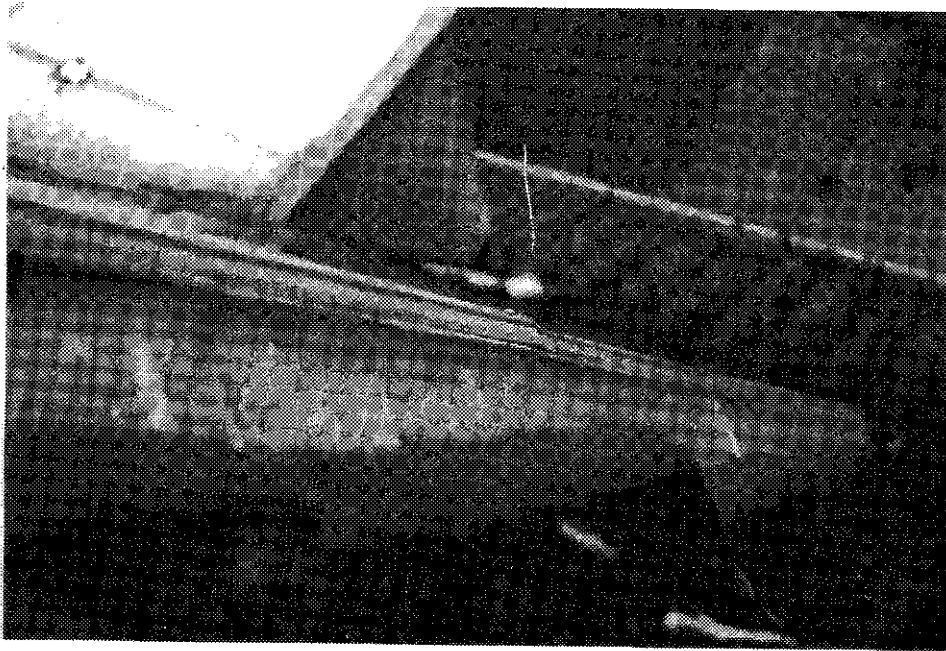

Fig. 6. The flashing of the collector sides.

8. A satisfactory humidity was measured in the backside insulation of the collector

The loftroom behind the collector is used as a living room and we were therefore afraid that there might be moisture in the insulation material of the collector. A humidity sensor was inserted in a drilled hole in the wall, and the hole was taped. After a while a humidity of 30% RF was measured. Compared to the humidity in the living room, 38% RF, this shows that there is not any moisture in the insulation material which is closest to the room.

FLAT PLATE SOLAR COLLECTORS ^{4 c} RELIABILITY AND DURABILITY

9. An evaluation of the collector after 3 years of operation

The collector has been reliable for a long time now, after a short period in the beginning with leakage problems. It also seems to have a good durability, and the problems mentioned in the previous items should not affect this conclusion. The reason for the good durability could be that a good cover solution is used, which has been known from greenhouses for many years.

The efficiency of the collector and the rest of the solar system is also quite good. The solar heating production of the system was measured from August 1979 to August 1980, it was 2100 kWh or 150 kWh per m². In the same period a mean of 260 litres of hot water was used a day. The optimal size of a domestic hot water solar system for this consumption is in Denmark considered to be a 8-10 m² system.

FLAT PLATE SOLAR COLLECTORS RELIABILITY AND DURABILITY

4 d

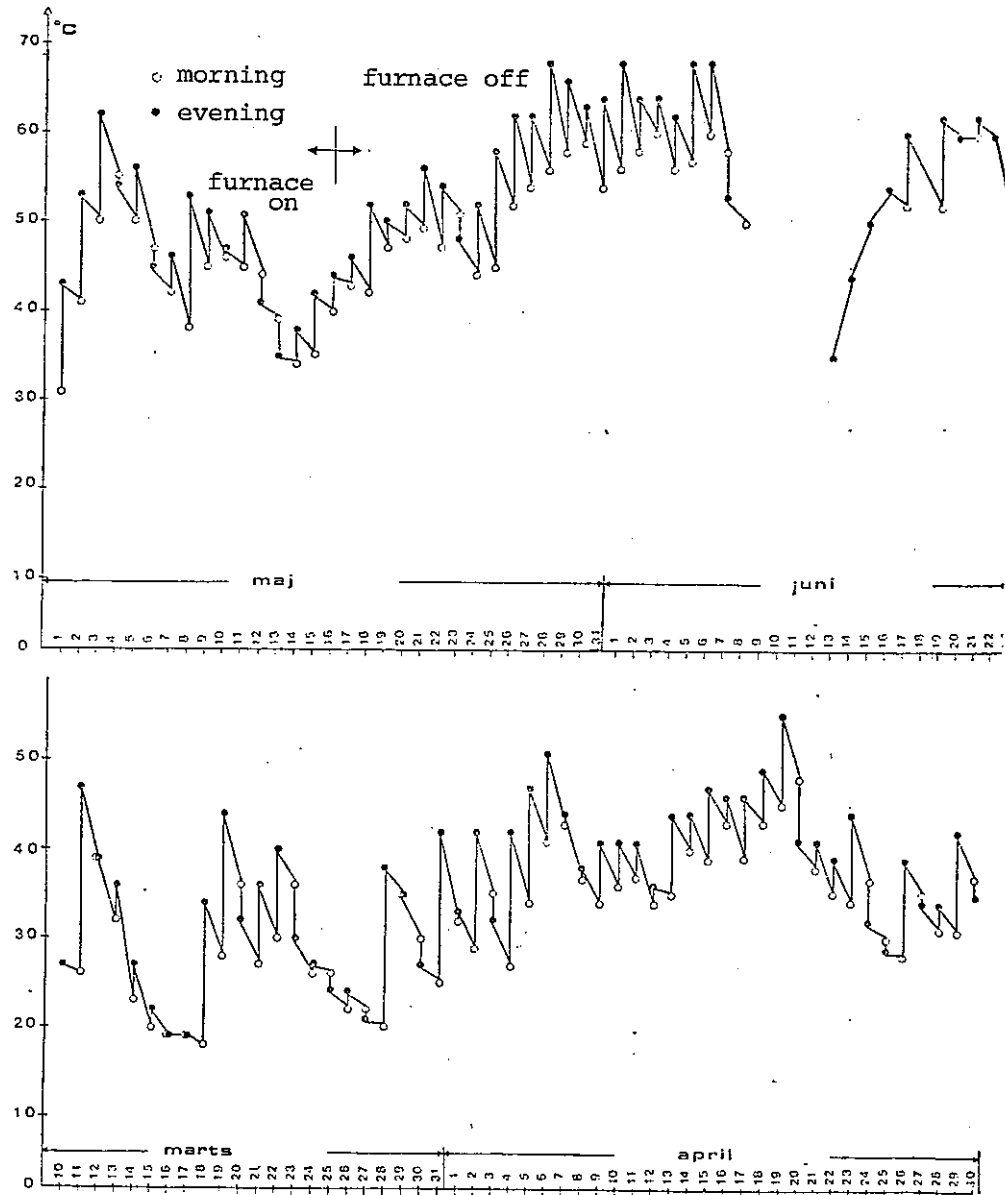

Fig. 7. Temperatures in storage tank, morning and evening from March to June 1979.

Fig. 7 shows storage temperatures from March to June 1979. From the middle of May the furnace was switched off. With the exception of a week with no sun, the storage has temperatures higher than 45 °C after this time.

In the spring we see that the solar system is good for pre-heating. It is the experience that during the winter time the storage has low temperatures, and there are only very few sunny days. The storage seldom exceeds 30° C in the winter.

FLAT PLATE SOLAR COLLECTORS RELIABILITY AND DURABILITY

4 e

In fig. 7 you can see that the lowest difference between the storage temperatures from evening to morning is about 2 °C. With no domestic hot water consumption that day this is an expression for the heat loss from the storage tank.

It is also seen that on sunny days in May or June the collector can raise the storage temperature from, for instance, 44 °C to 68 °C. If stratification is not taken into account, this is equal to 19.5 kWh or 1.4 kWh/m² delivered to the storage from the collector. In the summer on the most sunny days in Denmark, the insolation from the sun will be about 5.0 kWh/m², this means a system efficiency on those days of 28%. It must be noted that a calculation as the above mentioned must be taken with all kinds of reservations. The figures are not accurate, but can perhaps be used to tell you something of how the collector is operating.

FLAT PLATE SOLAR COLLECTORS RELIABILITY AND DURABILITY

1
L

DESCRIPTION OF SYSTEM, CONSTRUCTION AND FAILURE OF THE SOLAR COLLECTOR, DISCOVERED DURING EXAMINATION.

Institute: Department of Scientific and Industrial Research,
Physics and Engineering Laboratory, Private Bag,
Wellington, New Zealand

Author of report: R.F. Benseman

Date and hour for inspection: 28.10.80 1300 hours

Location of system: Ministry of Works & Development, Wellington

Manufacturer of collector: Colt Ventilation & Heating (NZ) Ltd.

Installation contractor:

Date of installation: April 1977

Type of system: Hot water supply to cafeteria and washrooms

Total number of collector panels inspected: 64

Heat transfer medium: Water. Flow (design) rate 80 litres/min

Safety system: Against freezing: pump circulates water

DESCRIPTION OF SYSTEM, FLOW DIAGRAM, PICTURE OF COLLECTOR:

SEE PHOTO ATTACHED 1A 1B

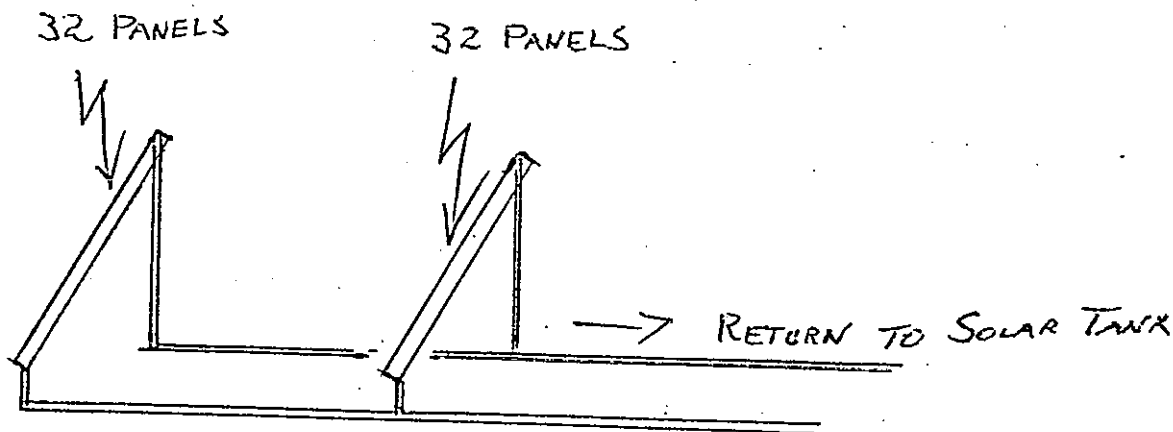

PUMP CIRCULATION & ACTIVATED BY SENSORS

FLAT PLATE SOLAR COLLECTORS RELIABILITY AND DURABILITY

2

DESCRIPTION OF SYSTEM, FLOW DIAGRAM, PICTURE OF COLLECTOR.

Photo 1A. General view. Rear battery of panels nearly obscured.

Photo 1B. Rear panels and mounting frame.

DESCRIPTION OF COLLECTOR.

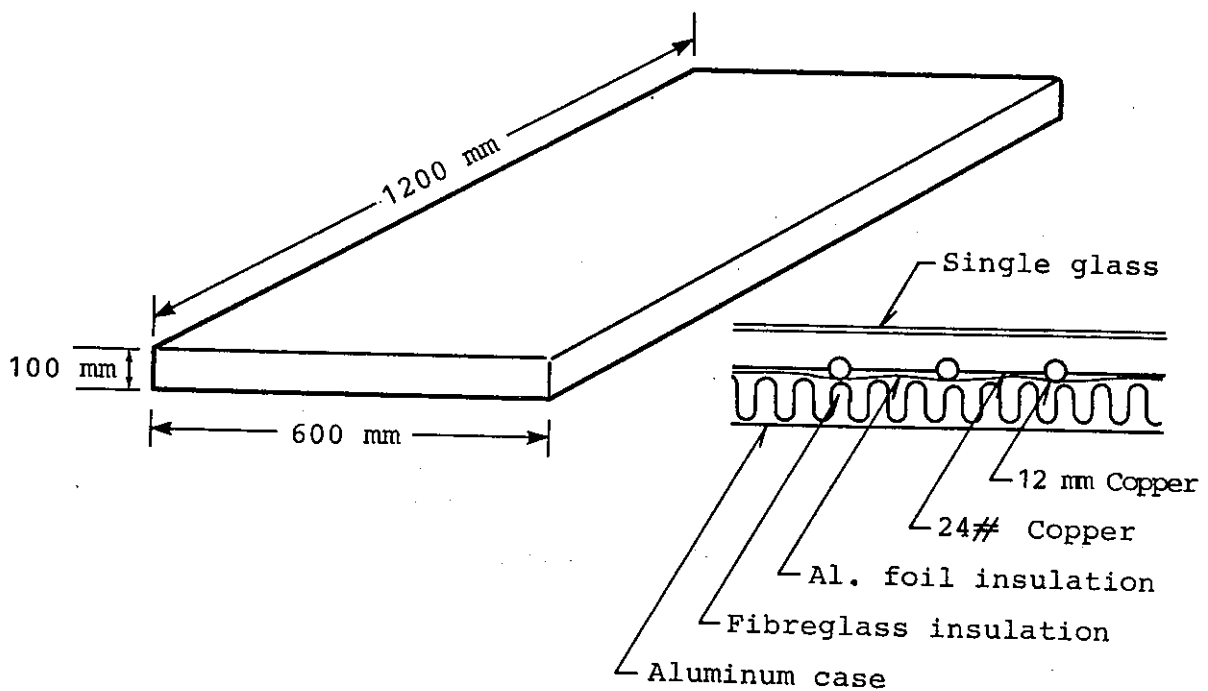

FLAT PLATE SOLAR COLLECTORS
RELIABILITY AND DURABILITY

3

COMPONENT DESCRIPTION (materials and manufacture procedure) :

Cover: Single glass 3mm

Absorber coating: Selective: Copper oxide

Absorber: Copper.

Insulation back: Fibreglass/Aluminium foil

Insulation sides: " "

Collector enclosure Aluminium alloy
back and edges:

Gaskets and sealants: Not known

Flashing: Aluminium

Attachments:

Other details: Photo 1C

NUMBER THE FAILURES FOUND DURING THE INSPECTION:

1. Corrosion at one junction of copper piping
2. Interior case corrosion (one place only)
3. Sand accumulation
4. Glass discolouration

FLAT PLATE SOLAR COLLECTORS RELIABILITY AND DURABILITY

4

REMARKS ON THE FAILURES.

Numbers refer to the list on page 3.

Description:

Potential cause:

How severe is the failure:

Possible remedy to avoid failures during production
and to mend it on the operating collector:

1. Corrosion on copper pipe

 See Photo 1D

 Corrosion products visible. Occurred only at this one joint. Probably due to poor cleaning after welding.

2. Interior corrosion of case

 See Photo 1E

 Corrosion products visible. Occurred only at this one location. Site is windswept and less than 1 km from sea - probably salt intrusion. Not yet serious.

3. Sand and dust accumulation

 See Photo 1F

 In about 4 collectors (back frame, top row, east end), small quantities of sand had accumulated in one corner. This is windy site and has had new buildings constructed nearby over last 2-3 years. Appears that wind has forced material through vent holes in casing, accumulating in same area of each collector. Not serious problem.

4. Glass Discolouration

 See Photo 1G

 This system is oversized for summer use, and on sunny days the water in the collectors boils and is released through the pressure relief valves shown in the photo. Boiling water rains down on the collectors nearby and has (over 3 years) produced a brown coating on the glass. Other collectors are clean (rain). Glass can probably be cleaned by scouring. Only 8 collectors affected.

Photo 1A

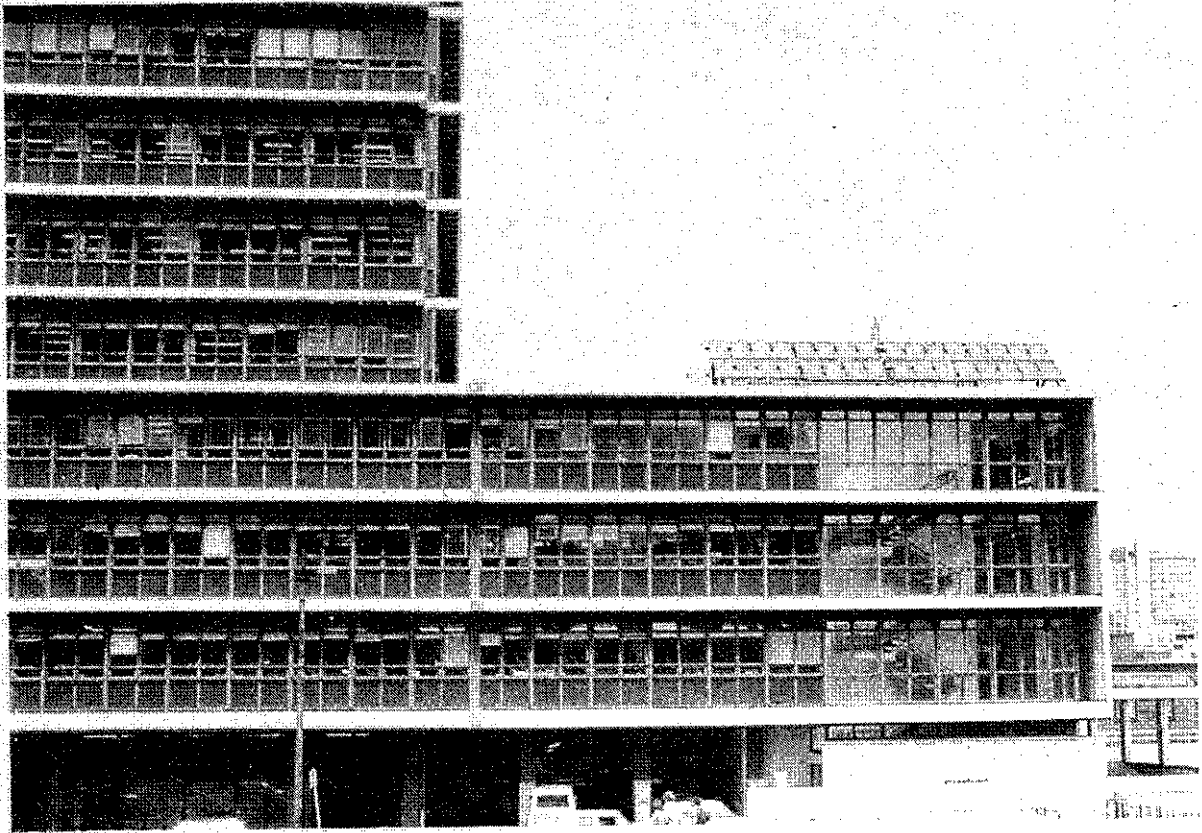
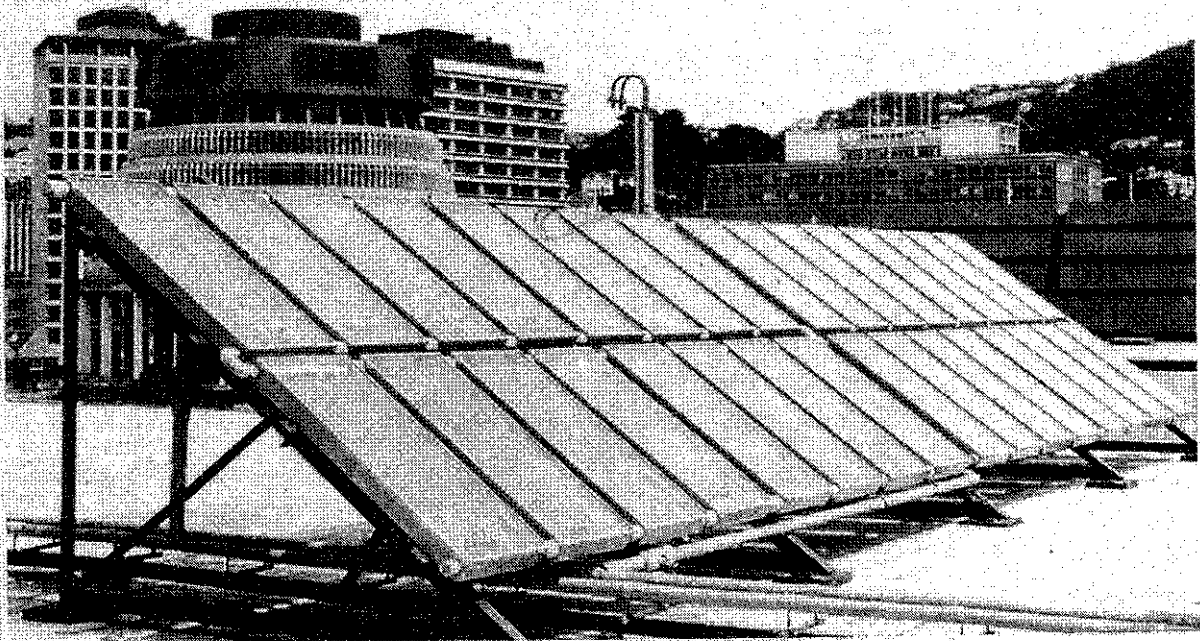
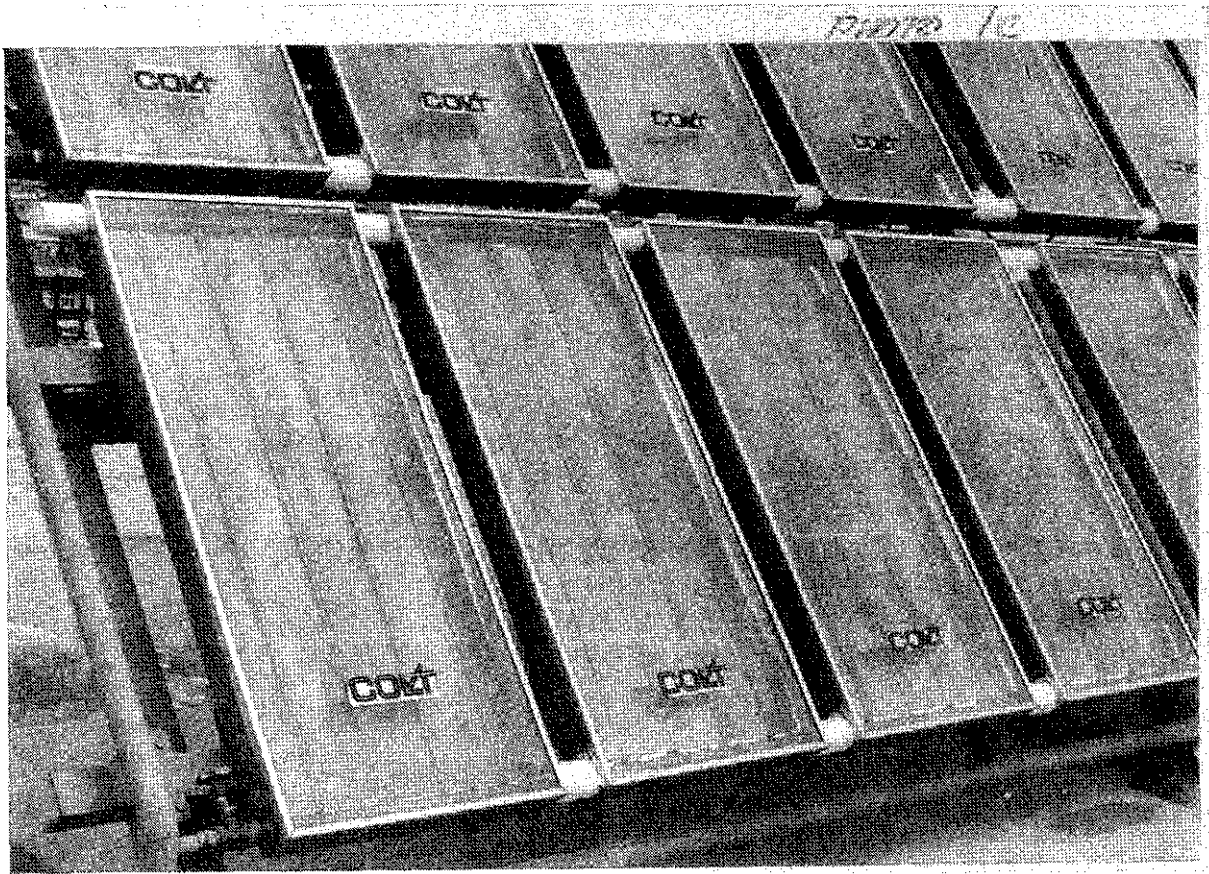

Photo 1B





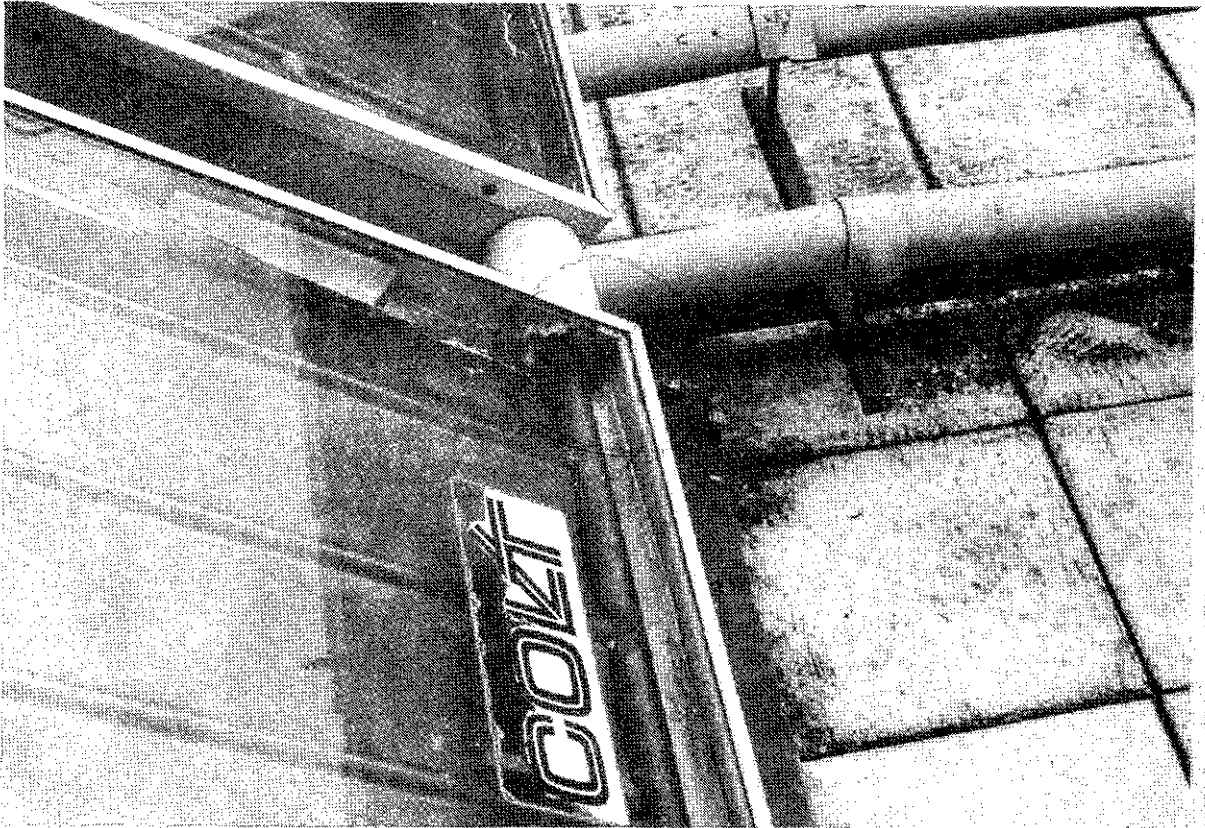
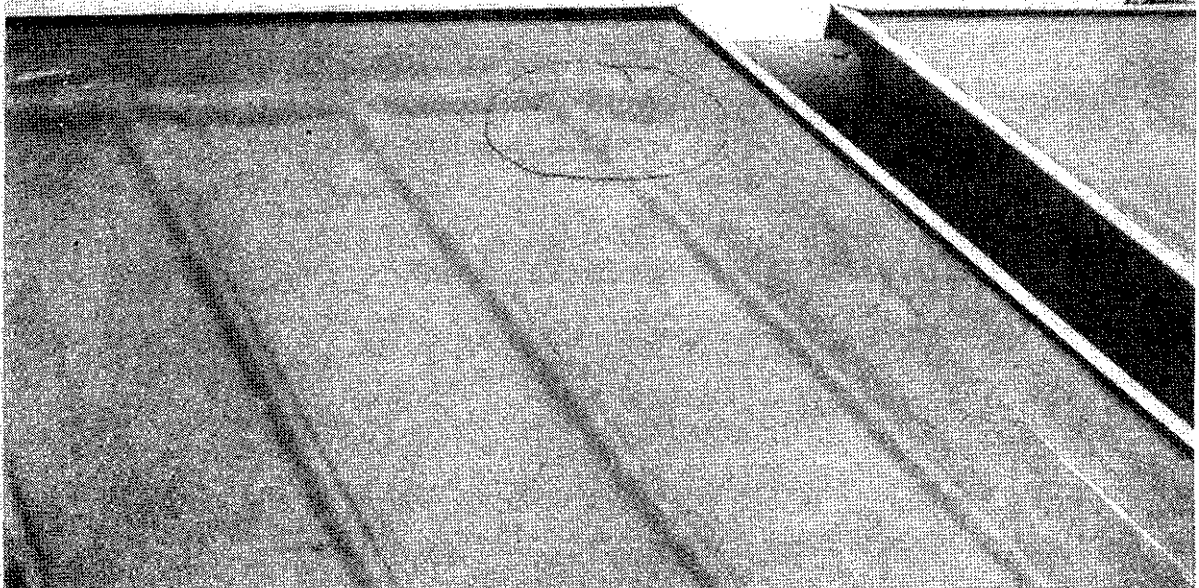
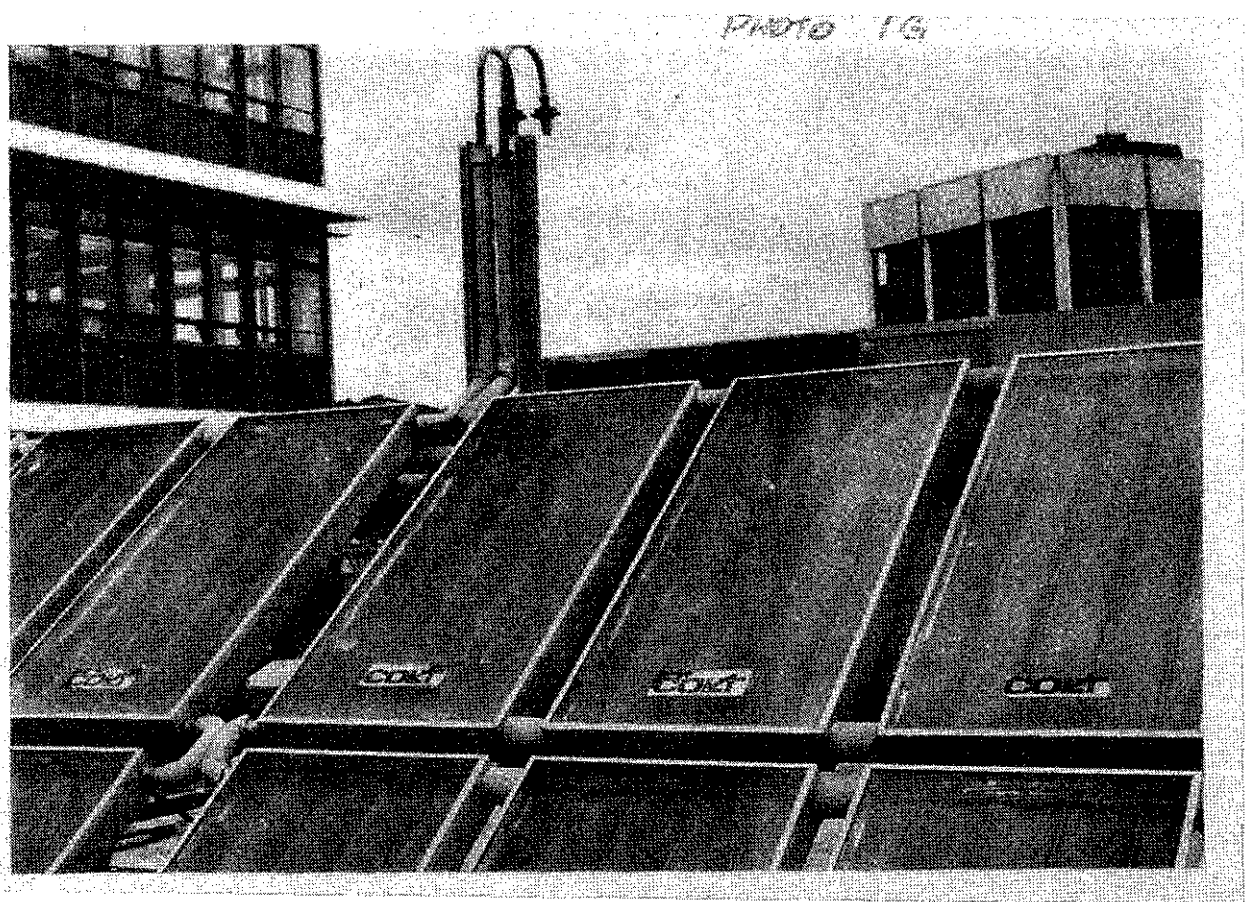

PHOTO 1E

PHOTO 1E





FLAT PLATE SOLAR COLLECTORS RELIABILITY AND DURABILITY

1
M

DESCRIPTION OF SYSTEM, CONSTRUCTION AND FAILURE OF THE SOLAR COLLECTOR, DISCOVERED DURING EXAMINATION.

Institute: Department of Scientific & Industrial Research,
Physics and Engineering Laboratory, Private Bag,
Wellington, New Zealand

Author of report: R.F. Benseman

Date and hour for inspection: 28.10.80 1500 hours

Location of system: Wellington East Post Office .

Manufacturer of collector: Colt Ventilation & Heating (NZ) Ltd.

Installation contractor:

Date of installation: 1977

Type of system: Hot water supply to cafeteria and washrooms

Total number of collector panels inspected: 24

Heat transfer medium: Water. Design flow 30 litres/min

Safety system: Against freezing: Pump circulates water

DESCRIPTION OF SYSTEM, FLOW DIAGRAM, PICTURE OF COLLECTOR:

System is essentially the same as that reported for Ministry of Works and Development, except that there is only a single battery of panels.

FLAT PLATE SOLAR COLLECTORS RELIABILITY AND DURABILITY

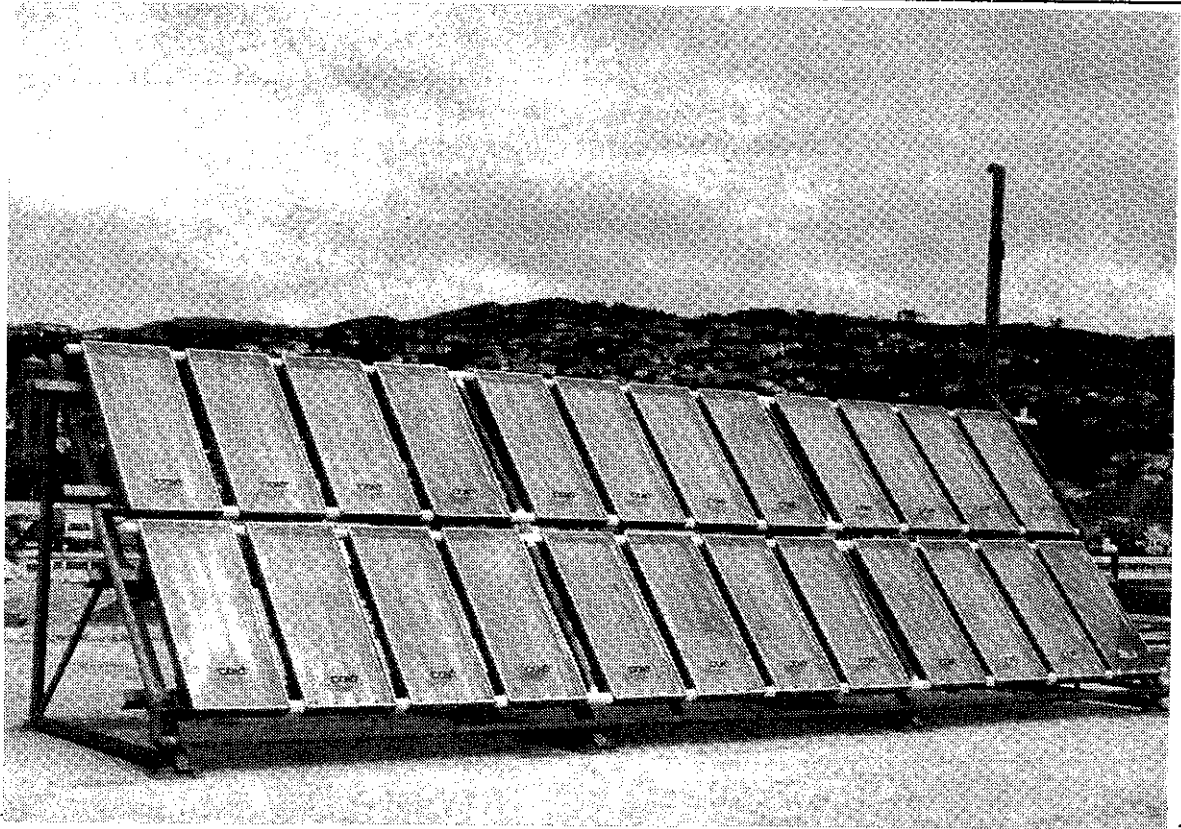

DESCRIPTION OF COLLECTOR.

See previous report

FLAT PLATE SOLAR COLLECTORS
RELIABILITY AND DURABILITY

3

COMPONENT DESCRIPTION (materials and manufacture procedure) :

Cover: Single glass 3mm

Absorber coating: Selective: Copper oxide

Absorber: Copper

Insulation back: Fibreglass/Aluminium foil

Insulation sides: " "

Collector enclosure back and edges: Aluminium alloy

Gaskets and sealants: Not known

Flashing: Aluminium

Attachments:

Other details: See Photo 1C

NUMBER THE FAILURES FOUND DURING THE INSPECTION:

No failures found. All components in good condition.

FLAT PLATE SOLAR COLLECTORS RELIABILITY AND DURABILITY

1
N

DESCRIPTION OF SYSTEM, CONSTRUCTION AND FAILURE OF THE SOLAR COLLECTOR, DISCOVERED DURING EXAMINATION.

Institute: Department of Scientific and Industrial Research,
Physics and Engineering Laboratory, Private Bag,
Wellington, New Zealand

Author of report: R.F. Benseman

Date and hour for inspection: 20.10.80 1600 hours

Location of system: Wellington, New Zealand

Manufacturer of collector:

Installation contractor:

Date of installation: September 1978

Type of system: Domestic hot water supply

Total number of collector panels inspected: 6

Heat transfer medium: Water

Safety system: None

DESCRIPTION OF SYSTEM, FLOW DIAGRAM, PICTURE OF COLLECTOR:

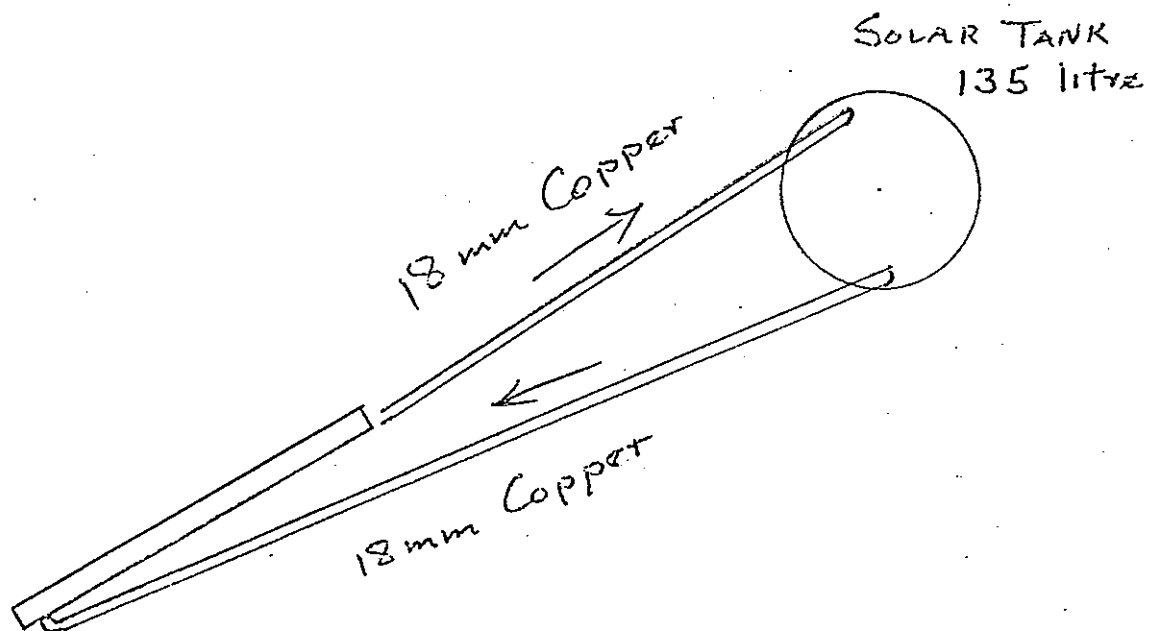

Directions for filling in the sheet is attached at the back.

FLAT PLATE SOLAR COLLECTORS RELIABILITY AND DURABILITY

2

DESCRIPTION OF SYSTEM, FLOW DIAGRAM, PICTURE OF COLLECTOR.

Photo 3A

DESCRIPTION OF COLLECTOR.

Dimensions: 1200mm x 600mm x 75mm

Collector: Steel sandwich, water filled, built-in heat exchanger to transfer heat to external copper circuitry.

FLAT PLATE SOLAR COLLECTORS RELIABILITY AND DURABILITY

3

COMPONENT DESCRIPTION (materials and manufacture procedure) :

Cover: Single glass 3mm

Absorber coating: Black paint

Absorber: Steel

Insulation back: Foamed polyurethane (foamed-in-place)

Insulation sides: " " "

Collector enclosure Galvanised steel
back and edges:

Gaskets and sealants: Glass fits into pressed recess in case
and is held and sealed with silicone rubber

Flashing:

Attachments:

Other details: Water in collector is sealed in for life.
Heat exchanger in panel transfers heat to
conventional flow and return pipes.

NUMBER THE FAILURES FOUND DURING THE INSPECTION:

1. Distortion of collector enclosure caused glass to separate from case. Subsequent leakage caused corrosion and condensation.
(Photo

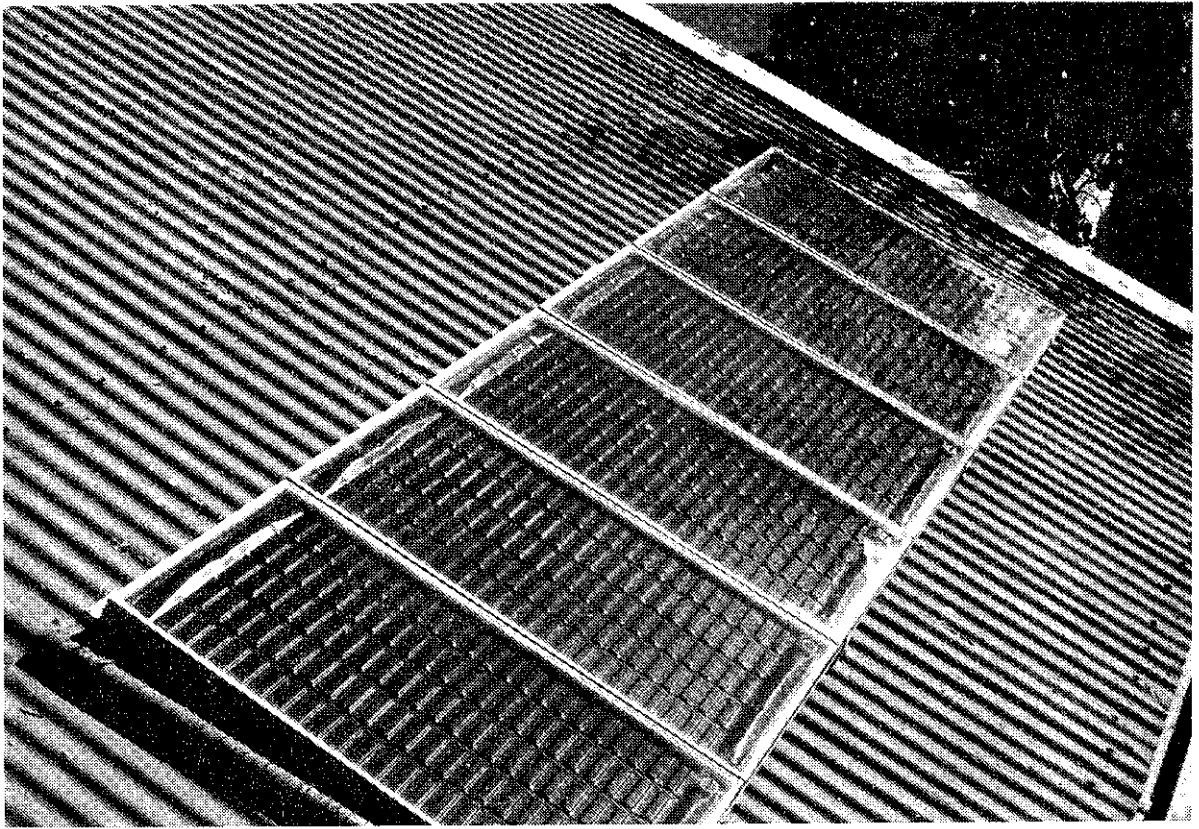

PHOTO 3B

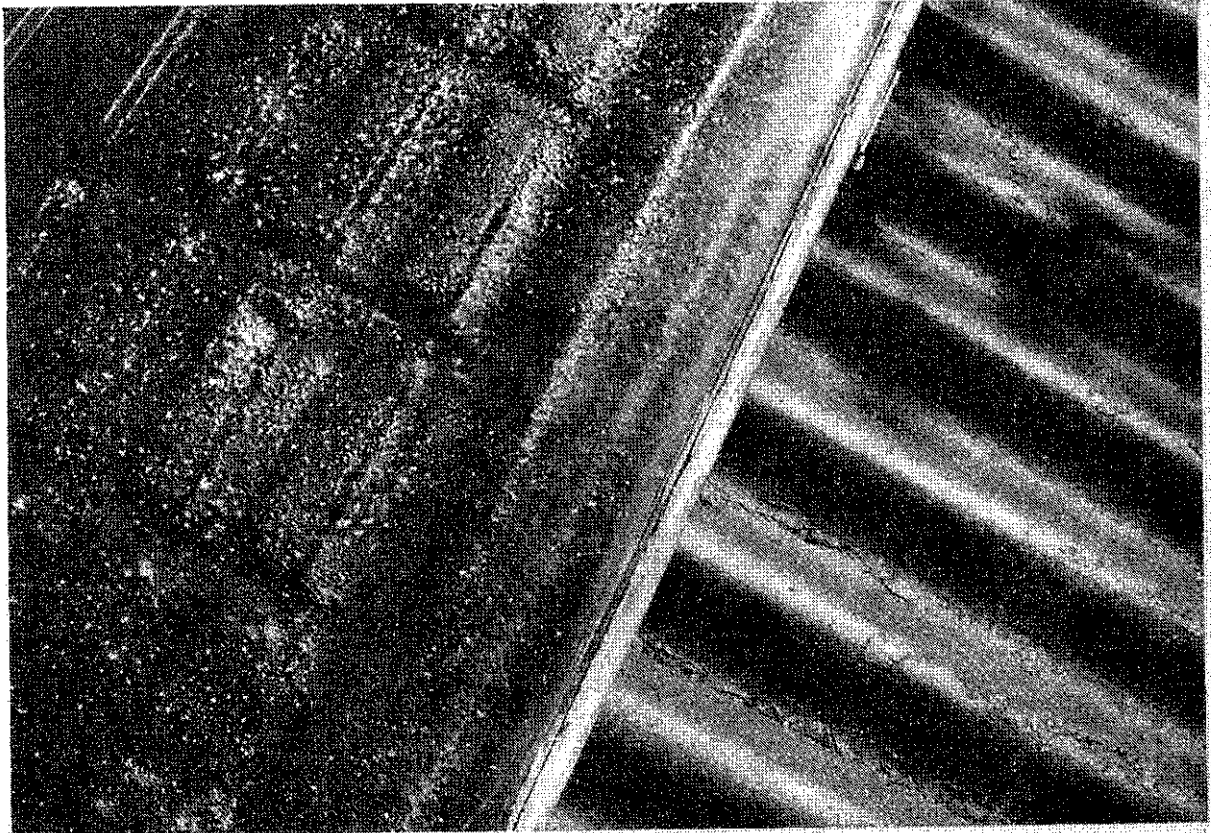

PHOTO 3C



FLAT PLATE SOLAR COLLECTORS, RELIABILITY AND DURABILITY

Description of system, construction and failure of the solar collector discovered during examination.

Institute: Institute of Applied Physics TNO-TH
P.O. Box 155, 2600 AD DELFT, The Netherlands

Author of report: D.E. Brethouwer

Date and hour for inspection: 1980-10-28 17.00 hrs.

Location of system: House 1,2,4 of the 4 solar houses in Zoetermeer,
52°08' latitude, 10 km east of The Hague.

Manufacturer of collector: DRU B.V., ULFT, Holland

Installation contractor: Installatie Techniek Bredero B.V.

Date of installation: March 1977

Type of system: Space heating and domestic hot water heating

Heat transfer media: Water-glycol (35%) 1200 l/h

Safety system: Overload heat exchanger

Description of system, flow diagram:

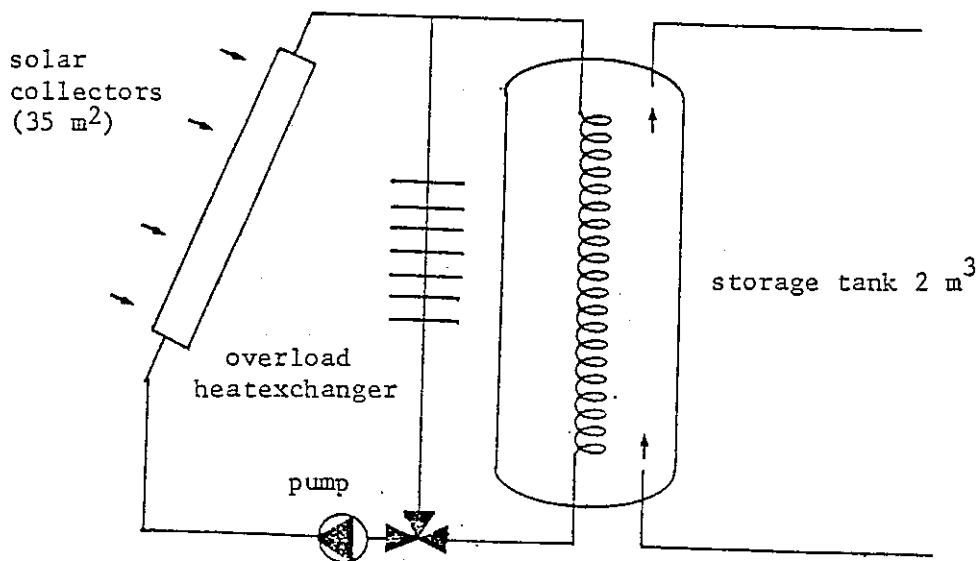

Directions for filling in the sheet is attached at the back.

Component description (materials and manufacturer procedure):

Cover: Single glass (4 mm)

Absorber coating: Tin oxide selective coating.

Absorber: Black enamelled steel

Insulation back: Glass-wool, 50 mm

Insulation sides: --

Collector enclosure

back and edges: Aluminium

Gaskets and sealants: Gaskets: Hemp.

Sealants: Silicone-rubber

compressable rubber strip

Flashing:

The enclosures are integrated in the roof.

Attachments:

The absorbers are positioned by means of the fittings.

Other details: --

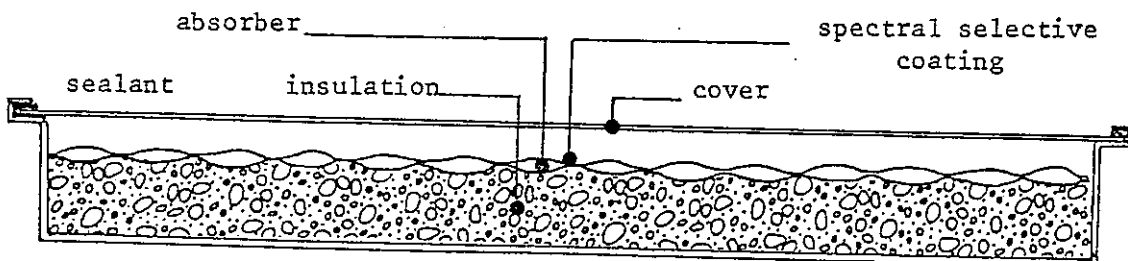
Description of collector:

Remarks

Number (see checklist)

Description:

Potential cause:

Possible remedy to avoid failure during production
and to mend it on the operating collector:

1. In the early morning condensation may occur on the inside of the glass cover, due to the low temperature of this pane and because it is ventilated with ambient air.
This condensation caused a slight weathering of the inside surface of the pane.
2. During the three years' period the panes have not been cleaned. It seems that there is a stabilisation of dirt after a few months, only near the corners and the edges some extra dirt is observed.
3. In one of the 90 collectors there has been a leakage of rain. This was caused by a bad sealing between the cover and the enclosure.
Remedy: more attention to the fitting of the sealants.
4. Due to uncareful handling during transport and mounting, the coat of enamel on some corners near the connections was cracked, followed by corrosion.
5. In one collector a small leakage was observed, probably caused by a bad spot in the weld (see picture 1).
6. After three years the mixture of water and glycol had to be changed, as indicated by the supplier of the glycol.
The new glycol was of a non-poisonous type.

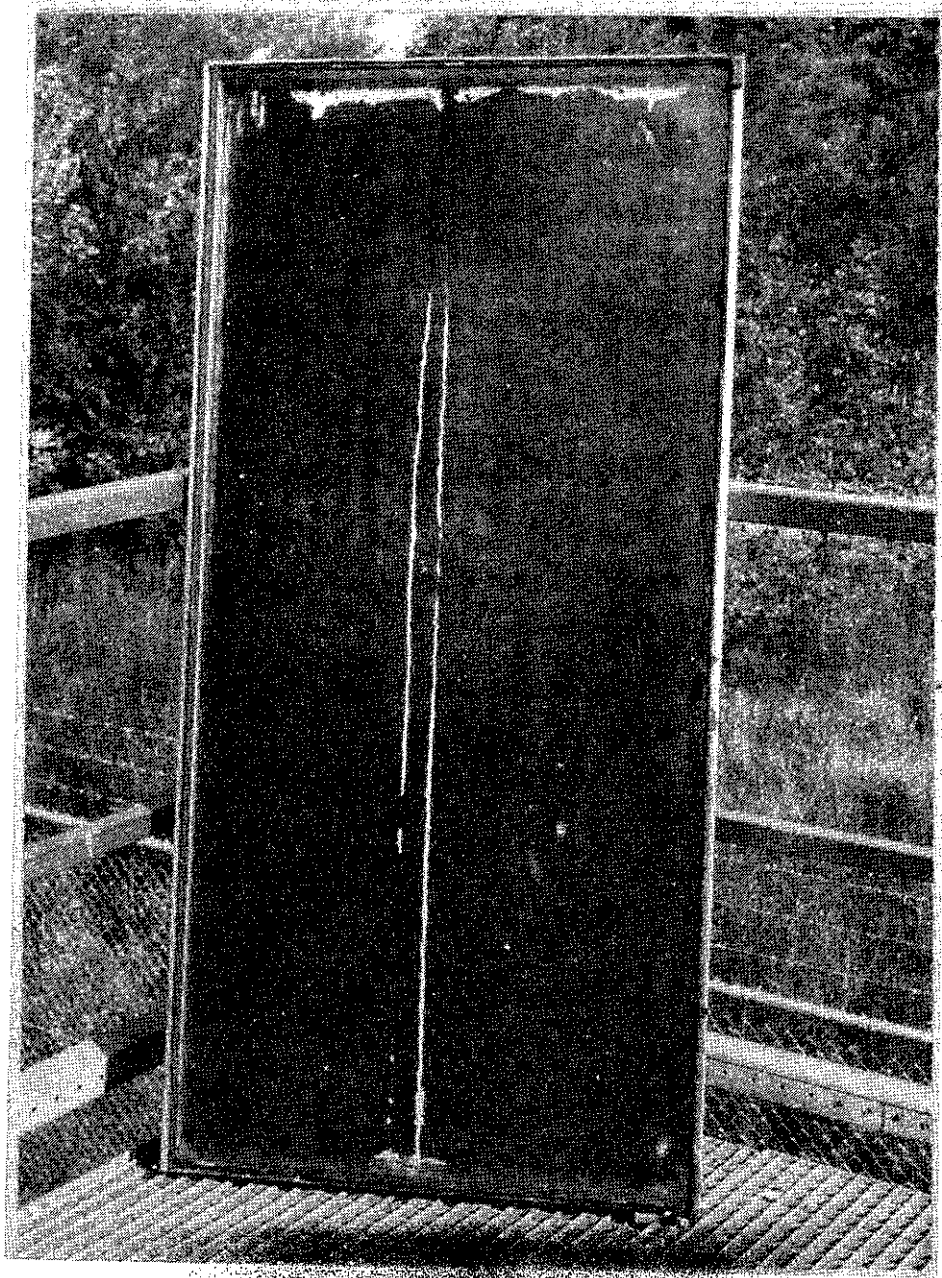

FLAT PLATE SOLAR COLLECTORS, RELIABILITY AND DURABILITY **P**

Description of system, construction and failure of the solar collector discovered during examination.

Institute: Institute of Applied Physics TNO-TH
P.O. Box 155, 2600 AD DELFT, The Netherlands

Author of report: D.E. Brethouwer

Date and hour for inspection: 1980-11-13

11.00 hrs.

Location of system: ENSCHEDE, 52°5' latitude, Holland

Manufacturer of collector: DRU B.V., ULFT, Holland

Installation contractor: Design: Adviesburo Wiecherink, Enschede

Date of installation: Construction: Wolter & Dros, Enschede
March 1978

Type of system: Domestic hot water heating for a Food Inspection Service

Heat transfer media: Water

Safety system: Automatic drain down system, using nitrogen as a cushion gas.

Description of system, flow diagram:

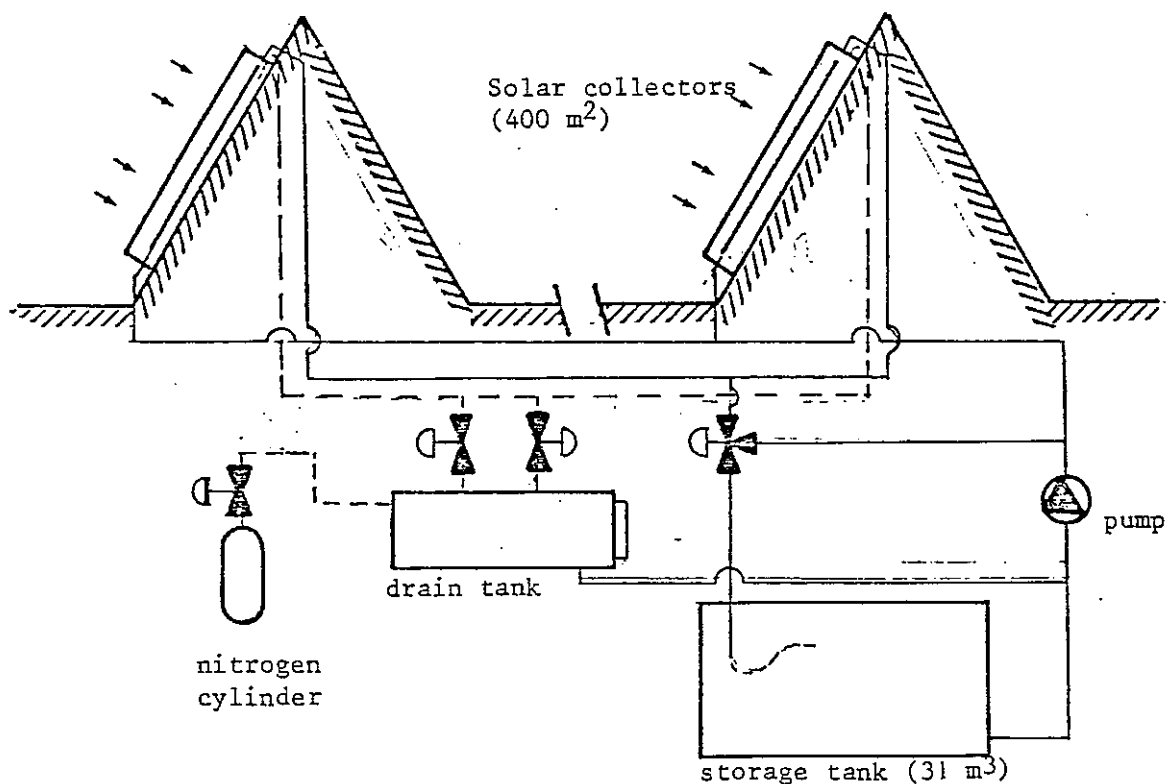

Directions for filling in the sheet is attached at the back.

Component description (materials and manufacturer procedure):

Cover: Single glass (4 mm)

Absorber coating: Tin oxide selective coating

Absorber: Black enamelled steel

Insulation back: 8 - 10 cm glass-wool

Insulation sides: --

Collector enclosure

back and edges: Aluminium, enclosed in the roof.

Gaskets and sealants: Gasket

Flashing: The 4 mm single glazing is attached in neoprene rubber, covered with aluminium profiles, used in the construction of greenhouses.

Attachments: The absorbers are positioned by their connections and a metal strip at the top.

Other details:

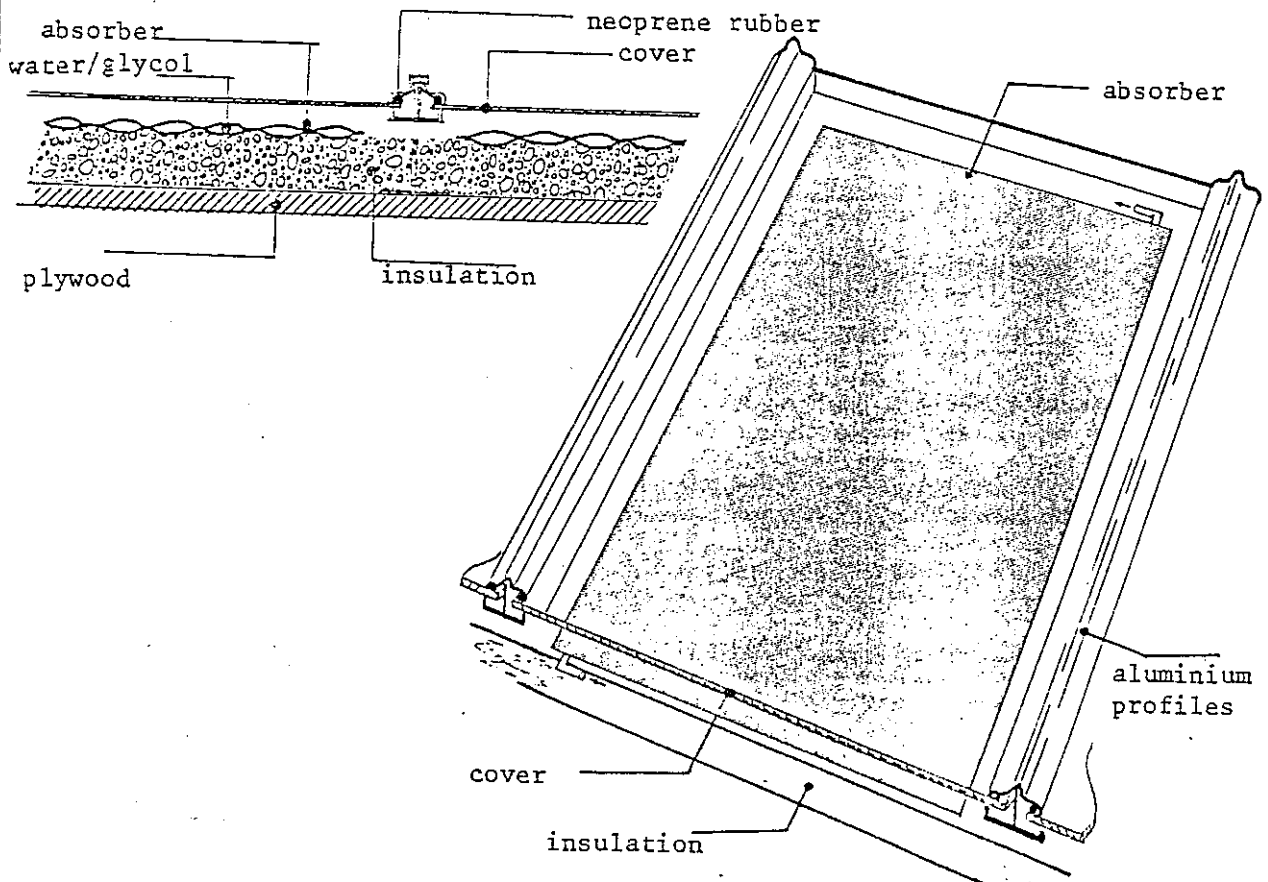
Description of collector:

Remarks

Number (see checklist)

Description:

Potential cause:

Possible remedy to avoid failure during production and to mend it on the operating collector:

1. Condensation appeared when the outdoor temperature was lower than 7-8 °C. When the glass cover was heated due to absorption of solar radiation, this condensation disappeared very fast.
2. Due to uncareful handling during transport and mounting the coat of enamel on some corners near the connections was cracked, followed by corrosion.
3. The glass-wool behind the absorbers was not pressed and bagged out, causing contact between the absorber and the glass-cover and/or the enclosure.
Remedy: usage of pressed insulation material.
4. The sensors of the filling system corroded.
This caused a high pressure in the absorbers because the filled situation was not sensed.

FLAT PLATE SOLAR COLLECTORS, RELIABILITY AND DURABILITY

Description of system, construction and failure of the solar collector discovered during examination.

Institute: Institute of Applied Physics TNO-TH
P.O. Box 155, 2600 AD DELFT, The Netherlands

Author of report: D.E. Brethouwer

Date and hour for inspection: 1980-11-12 09.00 hrs.

Location of system: Eindhoven, 51°28' latitude, Holland

Manufacturer of collector: LIPS, Drunen, Holland

Installation contractor: Eindhoven University of Technology

Date of installation: November 1976

Type of system: Space heating and domestic hot water heating

Heat transfer media: Water

Safety system: Mono-ethylene glycol filled expansion tubes in the collector and an overload heat exchanger in the ground.

Description of system, flow diagram:

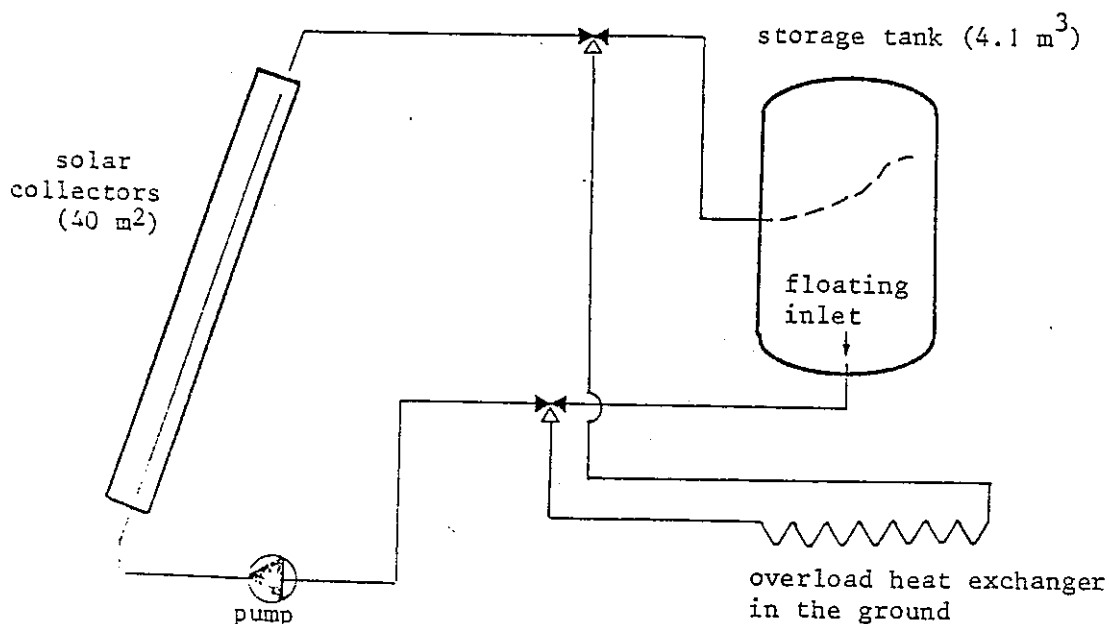

Directions for filling in the sheet is attached at the back.

Component description (materials and manufacturer procedure):

Cover: Single glass (4 mm)

Absorber coating: Black chrome

Absorber: Aluminium finned tubes

Insulation back: 4 cm glass-wool + 8 cm polyurethane foam

Insulation sides: 4 cm glass-wool

Collector enclosure

back and edges: The enclosure is integrated in the building construction of the roof.

Gaskets and sealants: Connection to the absorber-heads of silicone rubber hoses with hose clips.

Flashing: The 4 mm single glazing is attached in neoprene rubber, covered by aluminium profiles used in the construction of greenhouses.

Attachments: The absorbers are positioned by their connections.

Other details: Under the absorbers aluminium plates have been placed like rooftiles.

Description of collector:

silicone rubber hose
filled with glycol

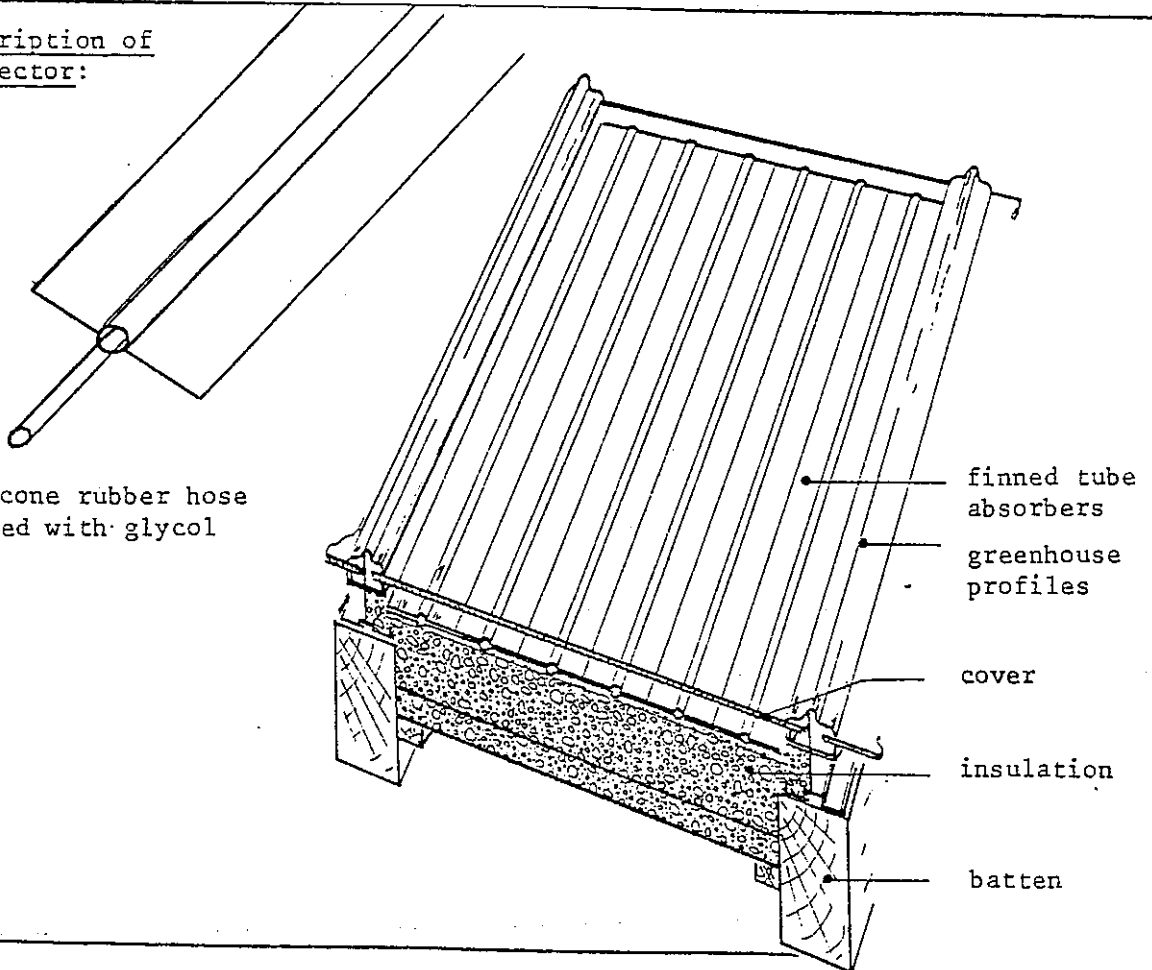

Remarks

Number (see checklist)

Description:

Potential cause:

Possible remedy to avoid failure during production and to mend it on the operating collector:

1. Condensation appeared when the outdoor temperature was lower than 7-8 °C. When the glass cover was heated due to the absorption of solar radiation this condensation disappeared very fast.
2. The glass cover was not cleaned in the four years after the installation. It seems that there is a stabilisation of dirt on the covers after two months.
There are two pyranometers in inclined position. One is placed behind the same glazing used as cover for the collectors. The transmission of this glass became about 3% lower in these four years, probably due to dirt on the glazing.
Special attention has to be paid during the sealing of the glass cover. When some silicone rubber comes on the glass and this is wiped off, there may be some rubber left. On this place the dirt has a much higher concentration.
3. The connection of the absorber to the absorber heads has leaked once, when there was a pressure of circa 2½ ato, due to no-flow conditions by intense radiation. Remedy: other type of connection without hoseclips.
4. There has been some diffusion of water into glycol and of glycol into water in the primary loop, because the silicone rubber hose is not vapour-tight.

FLAT PLATE SOLAR COLLECTORS, RELIABILITY AND DURABILITY
R

Description of system, construction and failure of the solar collector discovered during examination.

Institute: Institute of Applied Physics TNO-TH
P.O. Box 155, 2600 AD DELFT, The Netherlands

Author of report: D.E. Brethouwer

Date and hour for inspection: 1980-11-13 11.00 hrs.

Location of system: ENSCHEDE, 52°5' latitude, Holland.

Manufacturer of collector: LIPS, Drunen, Holland

Installation contractor: Design: Adviesburo Wiecherink, Enschede
Construction: Wolter & Dros, Enschede

Date of installation: March 1978

Type of system: Domestic hot water heating for a Food Inspection Service

Heat transfer media: Water

Safety system: Automatic drain down system, using nitrogen as a cushion gas.

Description of system, flow diagram:

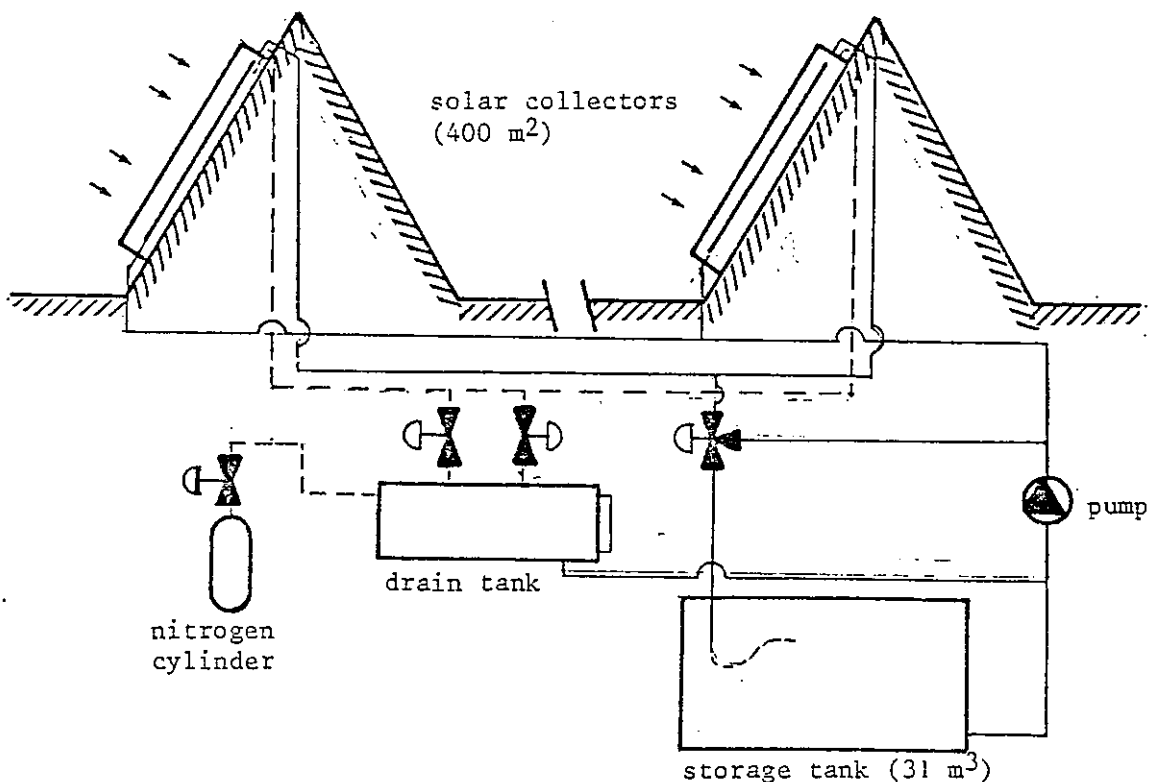

Component description (materials and manufacturer procedure):

Cover: Single glass (4 mm)

Absorber coating: Chromium oxide (black chrome)

Absorber: Aluminium finned tubes

Insulation back: 8 - 10 cm glass-wool

Insulation sides: --

Collector enclosure

back and edges: Aluminium enclosed in the roof.

Gaskets and sealants: Gasket (see checklist)

Flashing: The 4 mm single glazing is attached in neoprene rubber, covered with aluminium profiles, used in the construction of greenhouses.

Attachments: The absorbers are positioned by their connections and a metal strip at the top.

Other details:

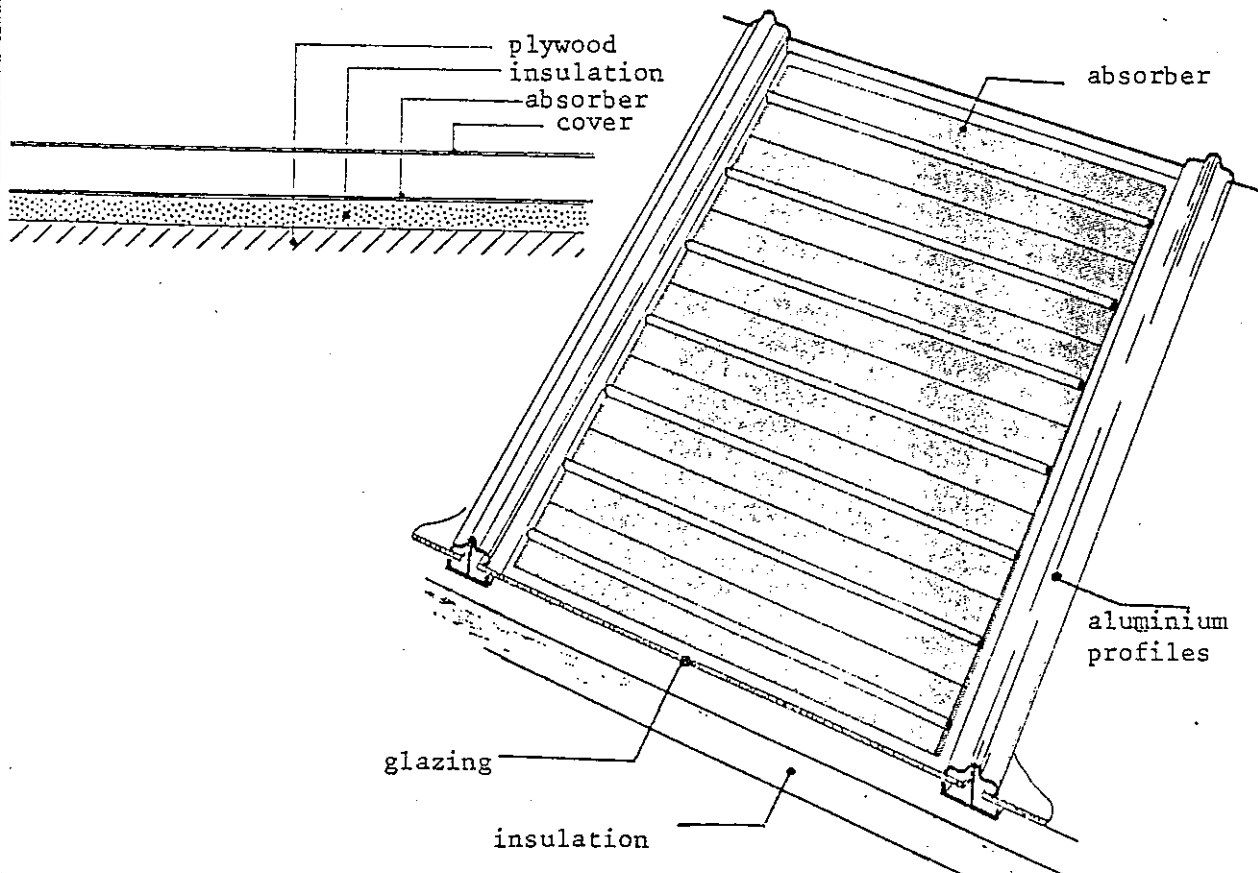
Description of collector:

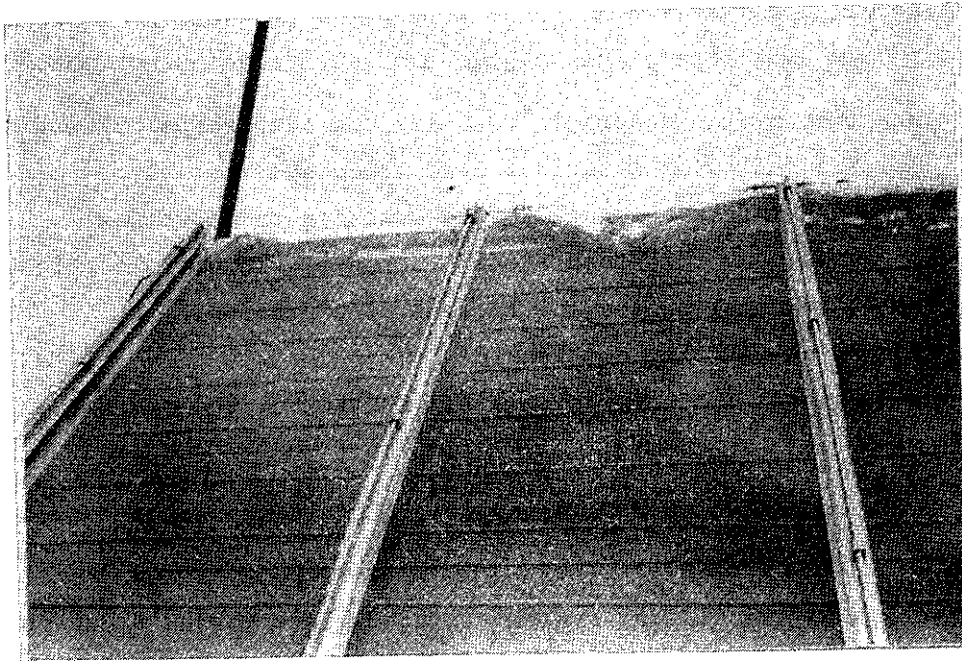
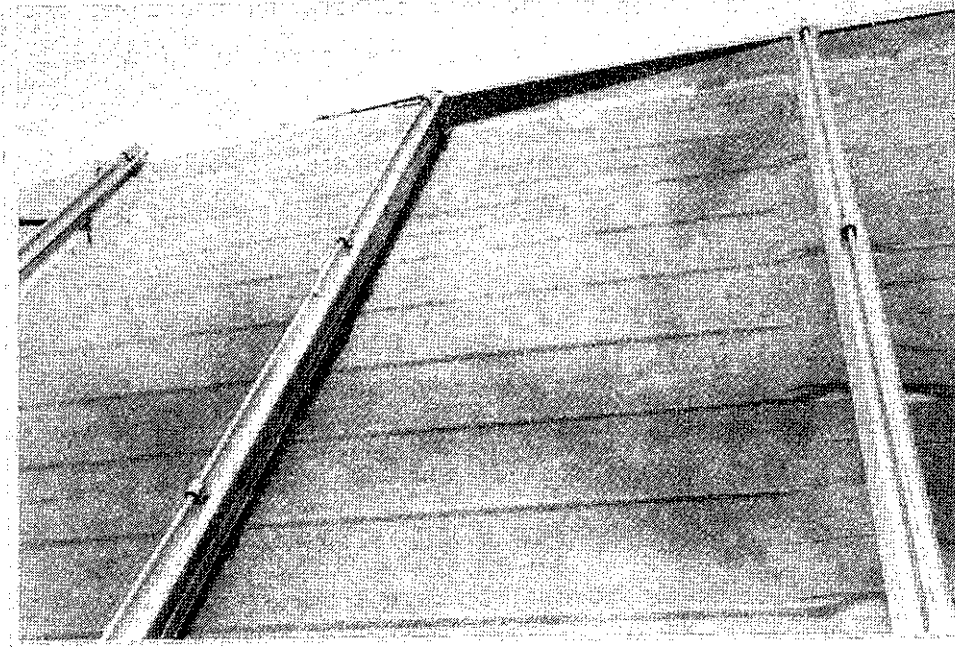

Remarks

Number (see checklist)

Description:

Potential cause:

Possible remedy to avoid failure during production and to mend it on the operating collector:

1. Condensation appeared when the outdoor temperature was lower than 7-8 °C. When the glass-cover was heated due to absorption of solar radiation, this condensation disappeared very fast.
2. It seemed that the absorber coating had turned a little greyer. There are no measured values. There is an indication that some salt has come on the absorber before mounting.
3. Due to the problems 4 and 8 the absorber coating flaked and the aluminium absorber corroded.
4. Draining the system, sometimes some water stayed in the tubes. When this water was frozen the tubes cracked, causing leakage afterwards.
5. Leakage due to the problems 4 and 8.
6. The glass-wool behind the absorbers was not pressed and bagged out, causing contact between the absorber and the glass cover and/or the enclosure.
Remedy: usage of pressed insulation material.
7. Due to problem 8 the enclosure had to be opened very often and was not mounted well afterwards.
A storm blew away some pieces of the enclosure (see photographs).
8. The connection of the absorber to supply and returnpipes caused big problems. The following solutions were tried successively:
 - silicone rubber tube: leakage due to cracking and notching
 - teflon coupling with thread fitted in the aluminium tubes: leakage due to big differences in the coefficient of expansion.
 - brass coupling with teflon: leakage
 - conical thread, fitted with Loctite: lasted for one year, then leakage again

At that time so many tubes were corroded that it was decided to stop this part of the primary loop.
9. The sensors of the filling system corroded. This caused a high pressure in the absorbers because the filled situation was not sensed.

FLAT PLATE SOLAR COLLECTORS, RELIABILITY AND DURABILITY

S

Description of system, construction and failure of the solar collector discovered during examination.

Institute: Los Alamos Scientific Lab.

"National Security and Resources Study Center"

Author of report: S.W. Moore

Date and hour for inspection: Jan. 2.4, 1980 at 1400 hours
Weather-clear, Previous precipitation 5 days ago.

Location of system: Los Alamos, N.M.

Manufacturer of collector: LASL-Collector Design. Turbo Refrigerating Co. - Collector fabrication and foaming. K-T Corp - Collector Ass., and glass retention strip fabrication Southwest Glass & Glazing Inc.

Installation contractor:

Date of installation: September, 1976

Type of system: Liquid - Flat Plate Collector - Heating & Cooling

Heat transfer media: Shell Thermia 33 paraffin base oil

Safety system: None - System protected from over pressure by P.R.V.

Description of system, flow diagram:

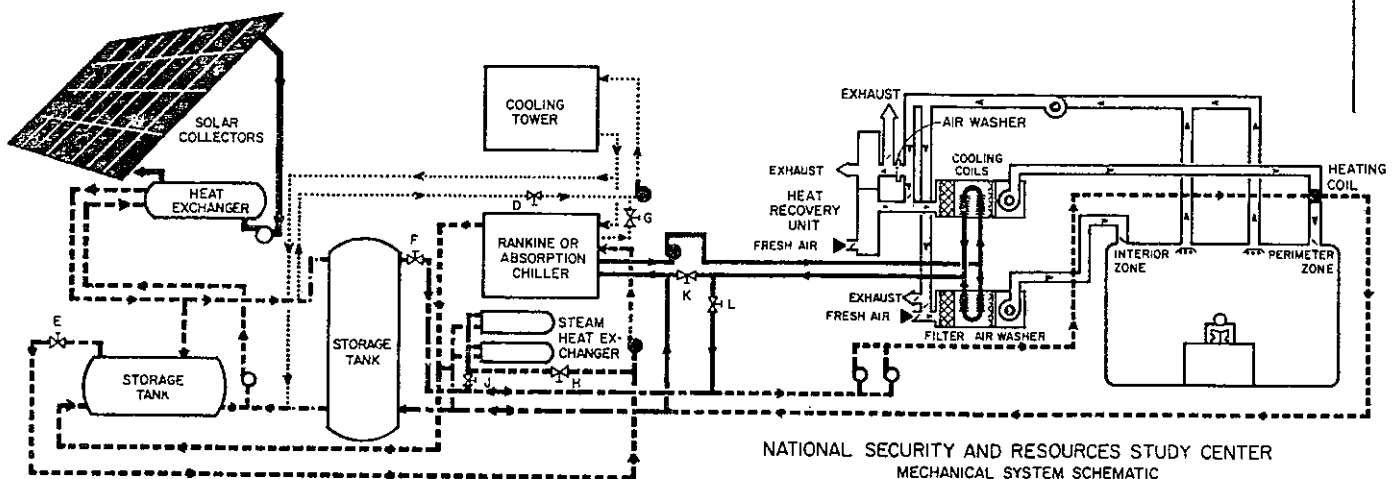

Directions for filling in the sheet is attached at the back.

Component description (materials and manufacturer procedure):

Cover: ASG, Pattern 76 Water White Glass, 1/8". Tempered single glazed

Absorber coating: Black Chrome on 1/2 mil nickel (min)

Absorber: Mild steel - Resistance seam welded and pressure expanded.

Insulation back: Urethane foam - CO₂ blown special formulation by the Bendix Corp. Fire barrier on underside

Insulation sides: None - Collectors butt together at sides

Collector enclosure: Structurally integrated - Mild steel nickel plated
back and edges: all over during Bl.Cr. process
(Same)

Gaskets and sealants: Extruded silastic (Baked at 400°F for 2 hrs) primary seal. Liquit silastic DC 132 secondary seal.

Flashing: Central portion of array-Mild Steel Bl. Cr.Coated. Perimeter of array-Galvanized flashing painted

Attachments: Bolted to structural purlins - Rigid bolting of bottom, sliding at top-four point bolting

Other details: Collectors make up the roof of the equipment room

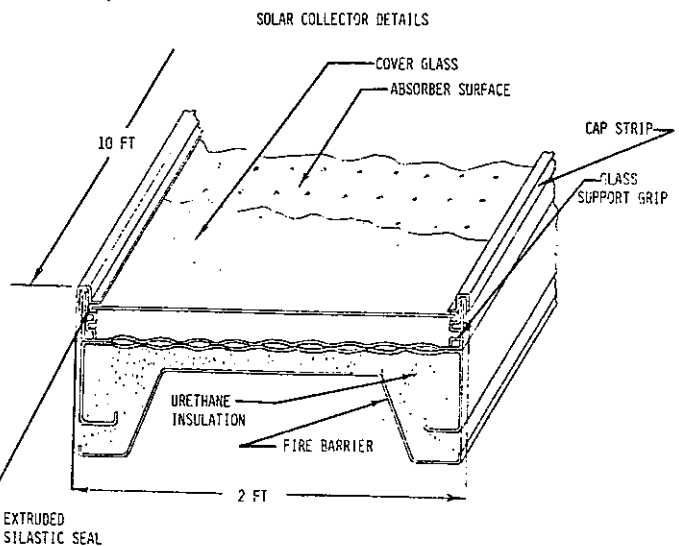
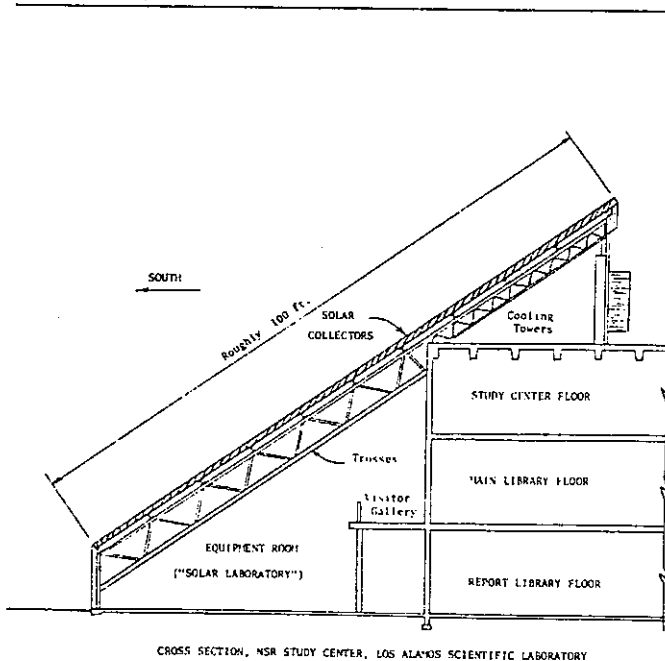
Description of collector:

Remarks

Number (see checklist)

Description:

Potential cause:

Possible remedy to avoid failure during production
and to mend it on the operating collector:

IM - Cover (Condensation)

At the time of inspection no water vapor condensation was present on the cover glass. After periods of rain, water condensate will be present on many collectors. This normally "burns off" in a few hours of clear conditions.

Permanent condensed deposits are apparent on many collectors at the lower corners. Much of this occurred during construction when the venting flow path was cut off due to a change in building construction. This was later rectified; however, the effect was not reversible.

At the time of inspection the exterior dirt deposits were so great it prevented seeing these permanent condensibles.

2M - Cover (Dirt or Deposits)

During this inspection much dirt was present on the outer surface of the cover glass. This occurs when conditions provide a wet cover glass outer surface, i.e., dew, frost, light rain, etc., accompanied by winds which deposit dust. This condition clears up after a moderate rain or snowfall.

3M - Absorber Coating (Dirt or Deposits)

Some dirt accumulation has taken place at the lower corners, vent areas, of the lower row of collectors. Much of this occurred when heavy equipment operated at the base of the array during initial construction. This problem occurs as a result of the fine balance needed between filtering and sufficient venting to prevent condensates.

4M - Flashing (Flaking)

Some paint flaking has occurred on the perimeter flashing for the array. This was a building contractor supplied component and is a typical example of paint flaking from a galvanized part.

Remarks

Number (see checklist)

Description:

Potential cause:

Possible remedy to avoid failure during production
and to mend it on the operating collector:

5M - Flashing or Sealants (Leakage)

Some rain leakage occurs at a few points during periods of heavy rain. They have occurred during initial construction and have never been investigated or a repair attempted.

6M - Attachments (Leakage)

There are approximately 12 points where minor leakage of the paraffinic oil leaks from piping system which attaches the collectors to the header system. Each collector, 404 total, has 16 joints of potential leakage which attaches it to the header. The maximum leakage is approximately 1/2 teaspoon/day from any of the leaks. This is not felt to be severe enough to warrant repair. All of these leaks appear to be coming from pipe fitting joints. All other leaks detected during initial leak tests or initial shakedown consisting of split elbows, cross threaded ferrules, joints not adequately tightened, etc., have been stopped.

One collector which had the internal piping damaged during installation was isolated from the system by the two shut-off valves and left in place.

Photos showing the collector array's external conditions are attached.

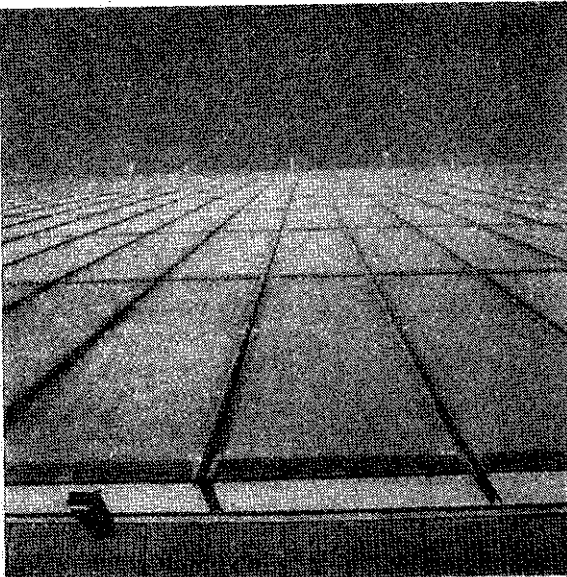
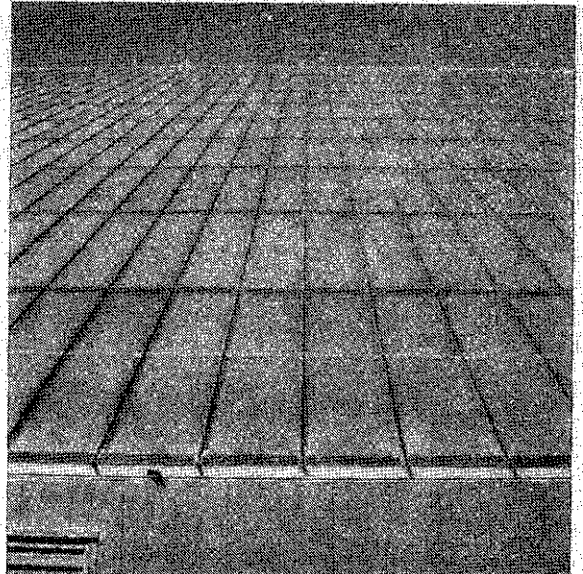

11/10/2010 10:10:10 AM

FLAT PLATE SOLAR COLLECTORS RELIABILITY AND DURABILITY

T1

DESCRIPTION OF SYSTEM, CONSTRUCTION AND FAILURE OF THE SOLAR
COLLECTOR, DISCOVERED DURING EXAMINATION.

Institute: Kernforschungsanlage Jülich, IKP-SOL,
Postfach 1913, D-5170 Jülich

Author of report: Heinz Riemer
Kernforschungsanlage Jülich, STE

Date and hour for inspection: 12.10.1979, 10.00 a.m.

Location of system: Borkum (island in the North Sea)

Manufacturer of collector: Messerschmitt-Bölkow-Blöhm GmbH
Postfach 801169, 8000 München 80

Installation contractor: Gebr. Sulzer, Bellevue, 2000 Hamburg

Date of installation: May/June 1979; startup = December 1979

Type of system: hot water supply system

Total number of collector panels inspected: total = 124

Heat transfer medium: ANTIfrogen N (80 %) water (20%), mass flow = 100 l (h-col-
lector)

Safety system: freeze protection: -40°C
heat transfer medium drain off at 95°C

DESCRIPTION OF SYSTEM, FLOW DIAGRAM, PICTURE OF COLLECTOR:

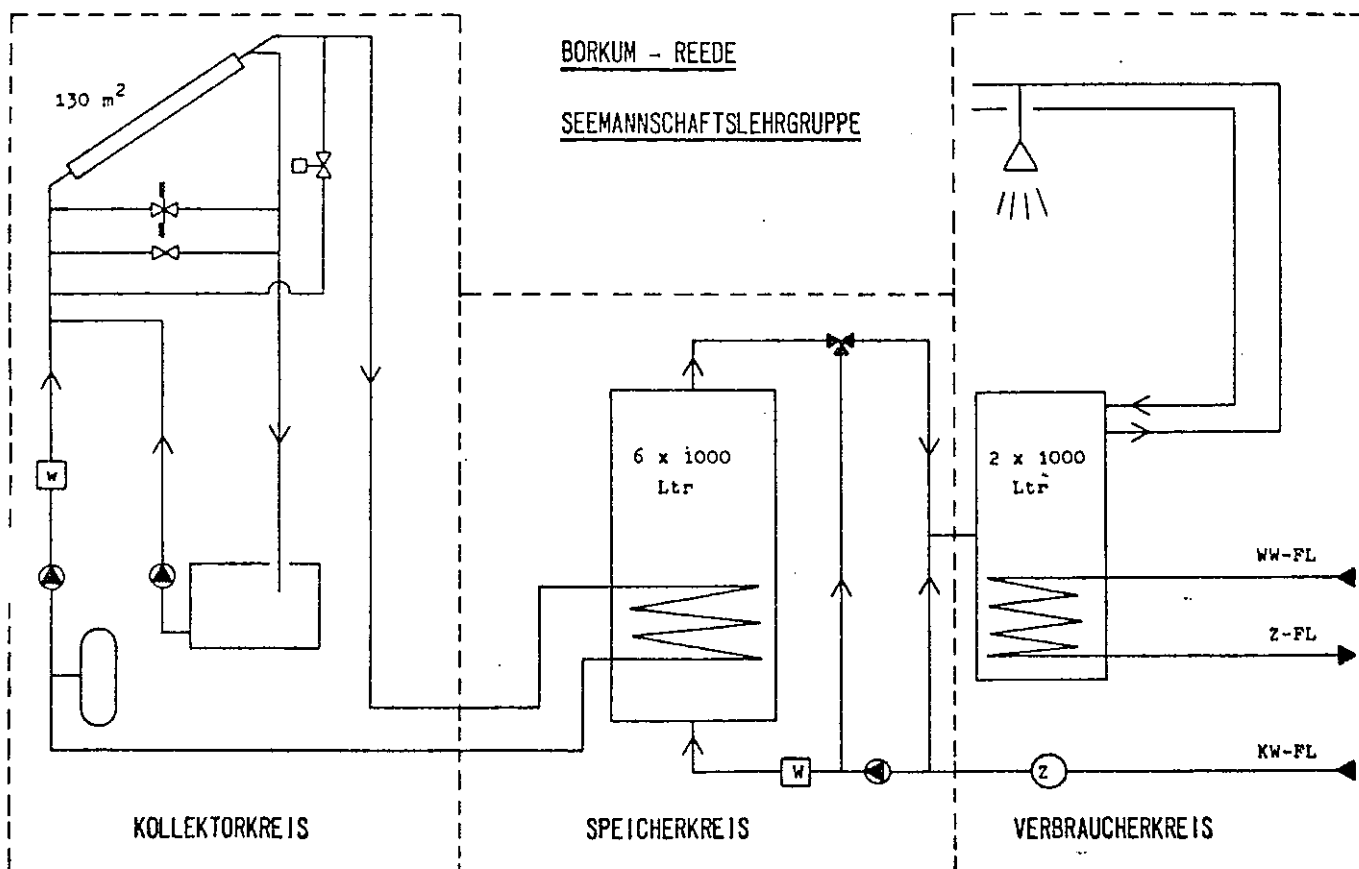

FLAT PLATE SOLAR COLLECTORS RELIABILITY AND DURABILITY

2

DESCRIPTION OF SYSTEM, FLOW DIAGRAM, PICTURE OF COLLECTOR.

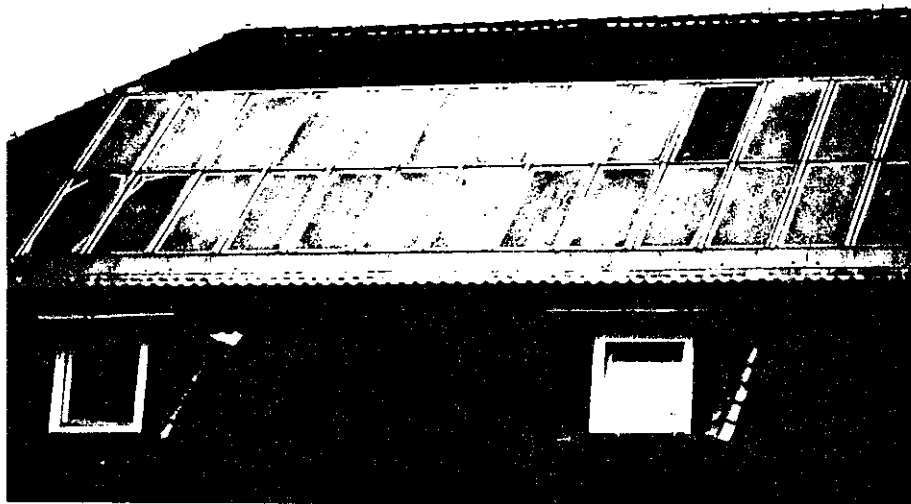

DESCRIPTION OF COLLECTOR.

MBB P 43 D

1. stainless steel casing
2. cellular plastic material
3. aluminium rollbond
4. 2 glass panes

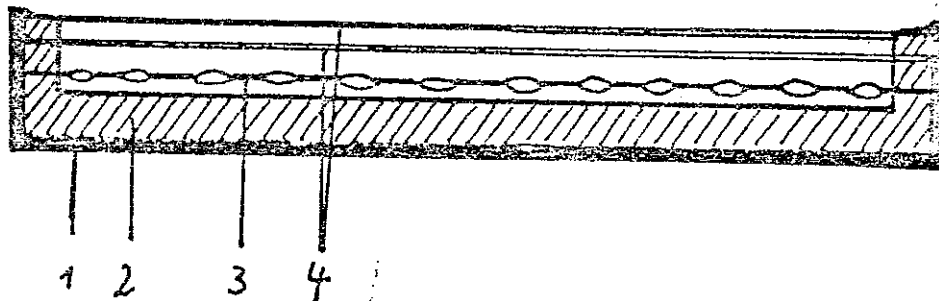

FLAT PLATE SOLAR COLLECTORS RELIABILITY AND DURABILITY

3

COMPONENT DESCRIPTION (materials and manufacture procedure):

Cover: 2 glass panes

Absorber coating: matt black

Absorber: aluminium rollbond

Insulation back:)
Insulation sides:) } cellular plastic material

Collector enclosure back and edges: stainless steel casing

Gaskets and sealants: not identified

Flashing: not identified

Attachments: integrated installation

Other details:

NUMBER THE FAILURES FOUND DURING THE INSPECTION:

1. condensation of covers
2. dirt or deposit of covers
3. cracking of insulation
4. warpage of insulation
5. warpage of enclosure
6. leakage of enclosure
7. leakage of sealants

FLAT PLATE SOLAR COLLECTORS RELIABILITY AND DURABILITY

4

REMARKS ON THE FAILURES.

Numbers refer to the list on page 3.

Description:

Potential cause:

How severe is the failure:

Possible remedy to avoid failures during production
and to mend it on the operating collector:

1. condensation: inherent design failure, insufficient sealing, non-vented cover system.
2. system is sited near coast line (island offshore in the North Sea); salt and sand is deposited permanently; natural cleaning by rain is not effective
3. + 4. insulation stripes between absorber and cover were not properly attached. Warpage is caused by operational temperature load.
5. + 6. warpage of enclosure caused leakage
7. type of failed sealants could not be identified

Remedy:

It was decided to replace the whole collector area by new collector modules. In contrast to the above inspected collectors, the new ones should have insulation stripes which are preheated before assembling the module.

FLAT PLATE SOLAR COLLECTORS RELIABILITY AND DURABILITY

1
T2

DESCRIPTION OF SYSTEM, CONSTRUCTION AND FAILURE OF THE SOLAR
COLLECTOR, DISCOVERED DURING EXAMINATION.

Institute: Kernforschungsanlage Jülich, IKP-SOL
Postfach 1913, D-5170 Jülich

Author of report: Klaus Maßmeyer, Heinz Riemer
Kernforschungsanlage Jülich, STE

Date and hour for inspection: 2.12.1980, 10.00 a.m. (II inspection report)

Location of system: Borkum (island in the North Sea)

Manufacturer of collector: Messerschmitt-Bölkow-Blohm GmbH,
Postfach 801169, 8000 München 80

Installation contractor: Gebr. Sulzer, Bellevue, 2000 Hamburg

Date of installation: May/June 1979; startup = December 1979

Type of system: hot water supply system

Total number of collector panels inspected: total = 124; inspected = 5

Heat transfer medium: Antifrogen N (80 %); water (20 %); mass flow = 100 l

Safety system: freeze protection: -40°C (h-collector)
heat transfer medium drain off at 95°C

DESCRIPTION OF SYSTEM, FLOW DIAGRAM, PICTURE OF COLLECTOR:

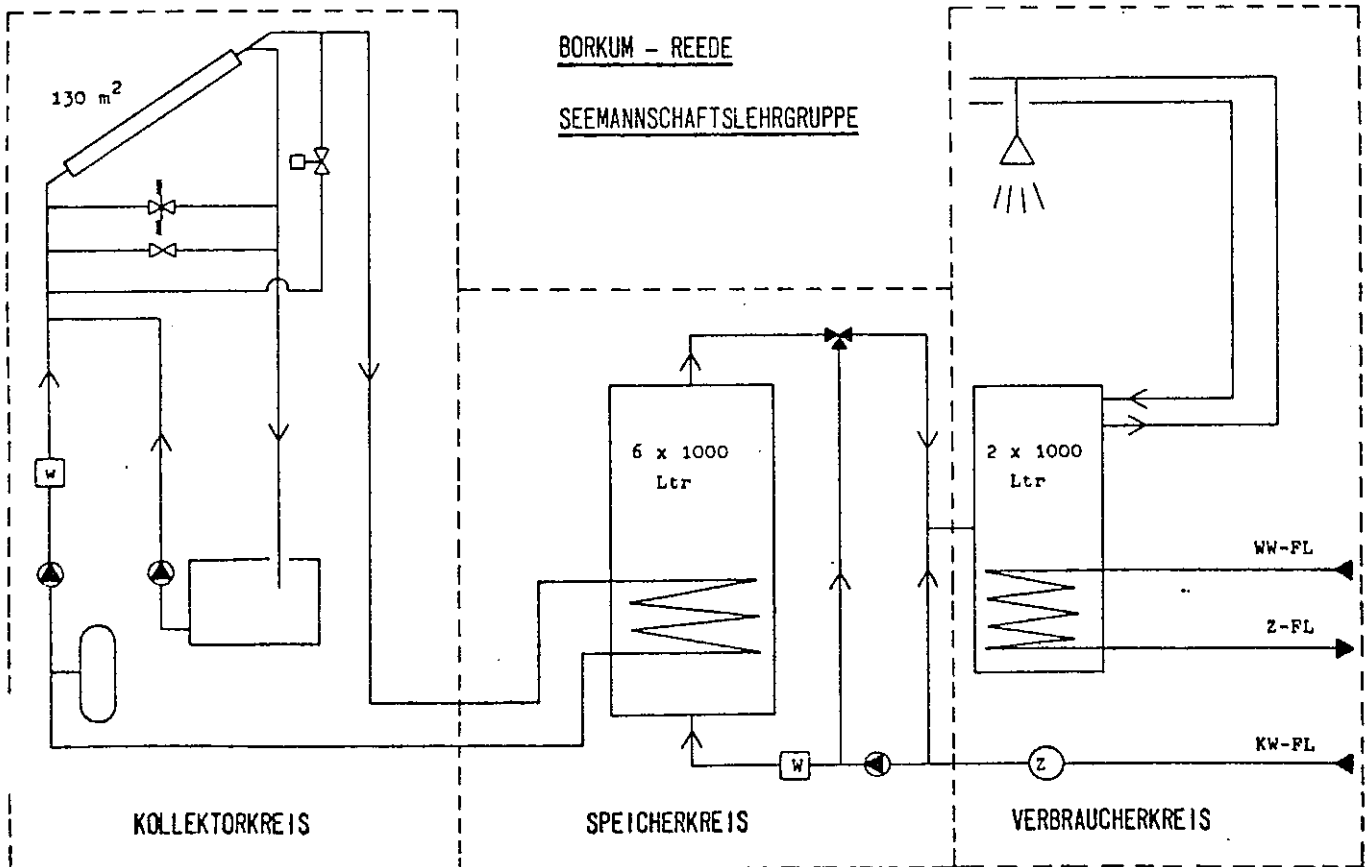

Directions for filling in the sheet is attached at the back

FLAT PLATE SOLAR COLLECTORS RELIABILITY AND DURABILITY

2

DESCRIPTION OF SYSTEM, FLOW DIAGRAM, PICTURE OF COLLECTOR.

DESCRIPTION OF COLLECTOR.

MBB P 43 D

- 1) stainless steel casing
- 2) cellular plastic material
- 3) aluminium rollbond
- 4) 2 glass panes

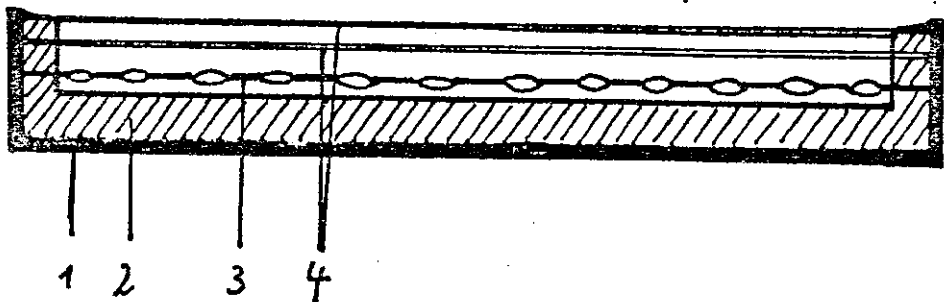

FLAT PLATE SOLAR COLLECTORS
RELIABILITY AND DURABILITY

3

COMPONENT DESCRIPTION (materials and manufacture procedure) :

Cover: 2 glass panes

Absorber coating: matt black

Absorber: aluminium rollbond

Insulation back: }
Insulation sides: } cellular plastic material

Collector enclosure back and edges: stainless steel casing

Gaskets and sealants: not identified

Flashing: not identified

Attachments: integrated installation

Other details:

NUMBER THE FAILURES FOUND DURING THE INSPECTION:

1. dirt and deposit of covers
2. corrosion of connections
3. leakage of attachments

FLAT PLATE SOLAR COLLECTORS
RELIABILITY AND DURABILITY

4

*REMARKS ON THE FAILURES.**Numbers refer to the list on page 3.**Description:**Potential cause:**How severe is the failure:**Possible remedy to avoid failures during production
and to mend it on the operating collector:*

1. System is sited near coast line (island offshore in the North Sea); salt and sand is deposited permanently; natural cleaning by rain is not effective.
2. Corrosion of the connections at collector inlet and outlet. This does not affect the normal operation.
3. Two of the attachments were not leak tight. The respective collectors were by-passed and are subjected to stagnation conditions. Nearly the whole collector field has been replaced during September/November 1980.

Remedy: To counteract the severe condensation inside of the cover surface, two holes were placed near the inlet and outlet attachments to enforce a stronger natural venting between cover and absorber plate.

FLAT PLATE SOLAR COLLECTORS RELIABILITY AND DURABILITY

1
U

DESCRIPTION OF SYSTEM, CONSTRUCTION AND FAILURE OF THE SOLAR COLLECTOR, DISCOVERED DURING EXAMINATION.

Institute: Institut für Kernphysik, KFA-JUELICH

Author of report: H. D. Talarek

Date and hour for inspection: repeatedly during 1980

Location of system: JUELICH, Fed. Rep. of Germany

Manufacturer of collector: BBC-Brown Boveri; Süddeutsche Metallwerke
D-6909 Walldorf

Installation contractor: KFA-SERVICE

Date of installation: Nov. 1977

Type of system: Hot-Water-System (BBC-SOLARWATT)

Total number of collector panels inspected: 5 panels

Heat transfer medium: BBC-SOLAQUID

Safety system: Safety valve (threshold = 2.5 bar)
freeze protection

DESCRIPTION OF SYSTEM, FLOW DIAGRAM, PICTURE OF COLLECTOR:

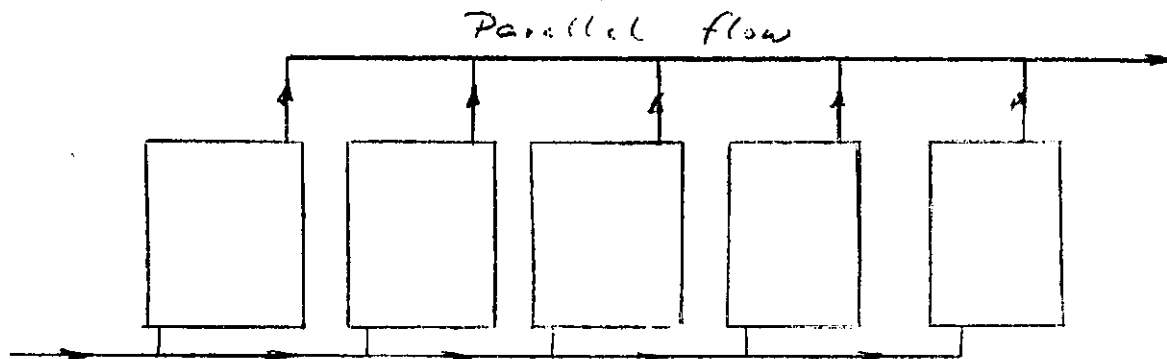

Flow Diagram

FLAT PLATE SOLAR COLLECTORS RELIABILITY AND DURABILITY

DESCRIPTION OF SYSTEM, FLOW DIAGRAM, PICTURE OF COLLECTOR.

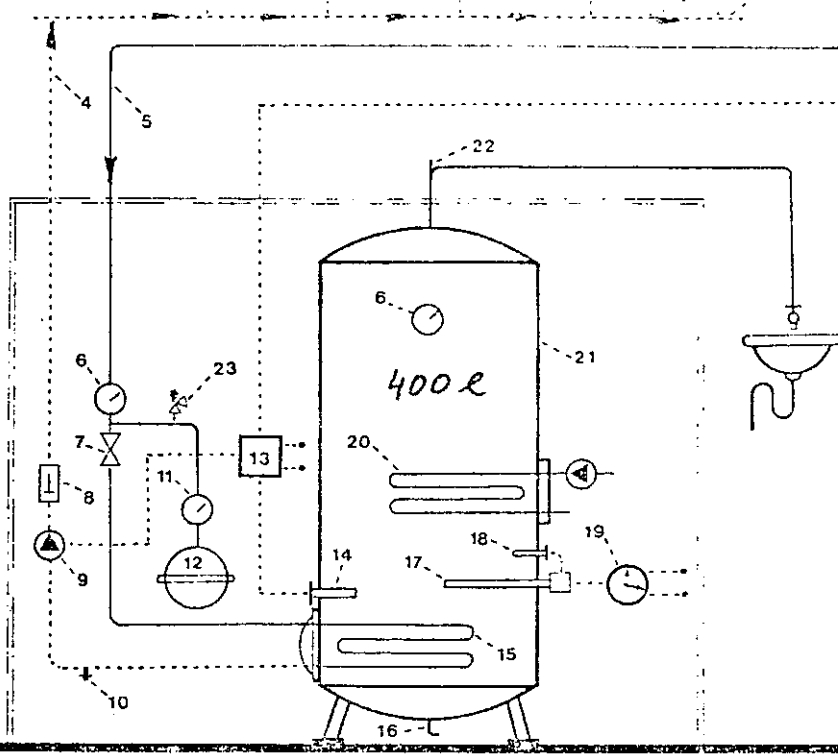

DESCRIPTION OF COLLECTOR.

CROSS SECTION

Aperture area: 1.1 m²

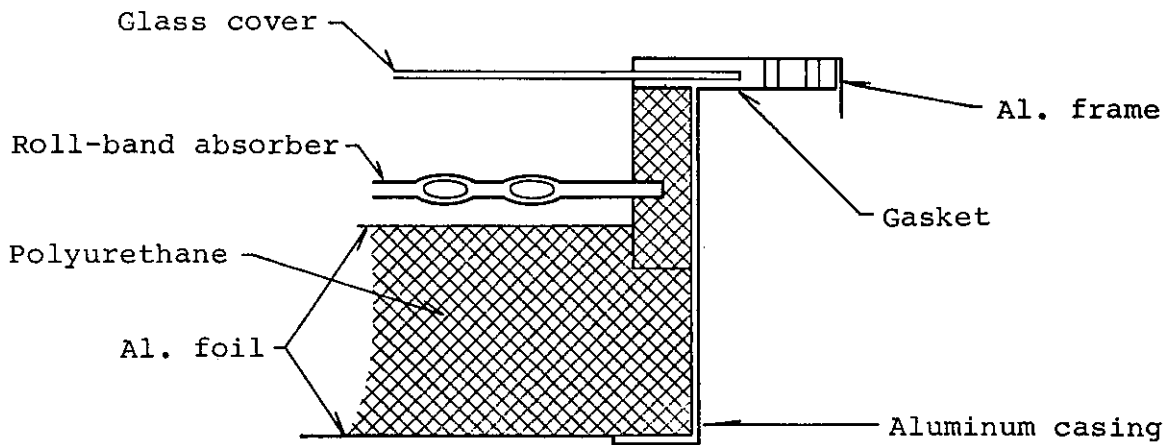

FLAT PLATE SOLAR COLLECTORS RELIABILITY AND DURABILITY

3

COMPONENT DESCRIPTION (materials and manufacture procedure):

Cover: single glass

Absorber coating: black paint

Absorber: aluminium (roll-bond)

Insulation back: polyurethan-foam (5 cm)

Insulation sides: -

Collector enclosure aluminium
back and edges:

Gaskets and sealants: rubber

Flashing: -

Attachments: -

Other details: 1.5 m x 0.88 m

NUMBER THE FAILURES FOUND DURING THE INSPECTION:

1. Condensation on covers (all collectors).
The collector situated in the middle of the array showed always a maximum of condensation.
2. Corrosion of the absorber plate (inner corrosion).
3. The outlet temperature sensor has loosened (bad thermal contact).
4. Heavy carbonic deposits were found around the heat-exchanger (tap water side).

FLAT PLATE SOLAR COLLECTORS RELIABILITY AND DURABILITY

REMARKS ON THE FAILURES.

Numbers refer to the list on page 3.

Description:

Potential cause:

How severe is the failure:

*Possible remedy to avoid failures during production
and to mend it on the operating collector:*

1. The collector array constantly shows condensation of water. The condensation pattern changes with the temperature gradient. Apparently this is caused by exchange of air with the environment.
This failure is considered to be of minor importance.
2. During the summer of 1980 a leaking absorber plate was detected, located in the central collector of the array and in the middle of the panel. It was possible to tighten the plate by a mechanical attachment. Potential cause for inner corrosion of the aluminium absorber plate could be a temporary ingress of air over an extended period of time at the occasion of the exchange of the heat transfer fluid.

Remedy

Recommendation: Protect permanently the primary loop system.

3. + 4. The failures are thought to be typical for hot water systems. They are mentioned to complete the report.

FLAT PLATE SOLAR COLLECTORS RELIABILITY AND DURABILITY

CHECKLIST TO BE USED WHEN EXAMINING SOLAR COLLECTORS *

Feature Detail	Condensation	Dirt or deposit	Discoloration	Corrosion	Outgassing	Flaking	Cracking	Warpage	Leakage	Breakage	Other degeneration
Covers	1	1	NF	-	-	-	-	-	-	NF	
Absorber coating	NF	2	2	NF	-	-	-	-	-	NF	
Absorber	NF	NF	NF	2	NF	NF	NF	NF	2	NF	
Insulation											
Enclosure											
Flashing											
Gasket						NF					
Sealants											
Mountings											
Connections											
Manifolds											
Heat transfer medium	NF	NF	NF	NF	NF	NF	NF	NF			PH values: Start → PH = 7.6 after 3 years → PH = 7.95
Remaining details											

*Number remarks for failure. Fill in NF for no failure, NA for not applicable and HC for not checked.

FLAT PLATE SOLAR COLLECTORS RELIABILITY AND DURABILITY

1
V

DESCRIPTION OF SYSTEM, CONSTRUCTION AND FAILURE OF THE SOLAR
COLLECTOR, DISCOVERED DURING EXAMINATION.

Institute: AUSTRIAN SOLAR AND SPACE AGENCY (ASSA)

Author of report: MANFRED F. BRUCK

Date and hour for inspection: 1980 11 27 11.00 a.m.

Location of system: VIENNA, A-1190 Gunoldstraße 14

Manufacturer of collector: HUGO THALHAMMER KG. A-8020 Gráz, Griesplatz 19-20

Installation contractor: - " -

Date of installation: NOVEMBER 1978

Type of system: DOMESTIC HOT WATER SYSTEM

Total number of collector panels inspected: 20

Heat transfer medium: WATER /ETHYLENE GLYCOL (30%)

Safety system: OPEN VENT, ANTIFREEZE

DESCRIPTION OF SYSTEM, FLOW DIAGRAM, PICTURE OF COLLECTOR:

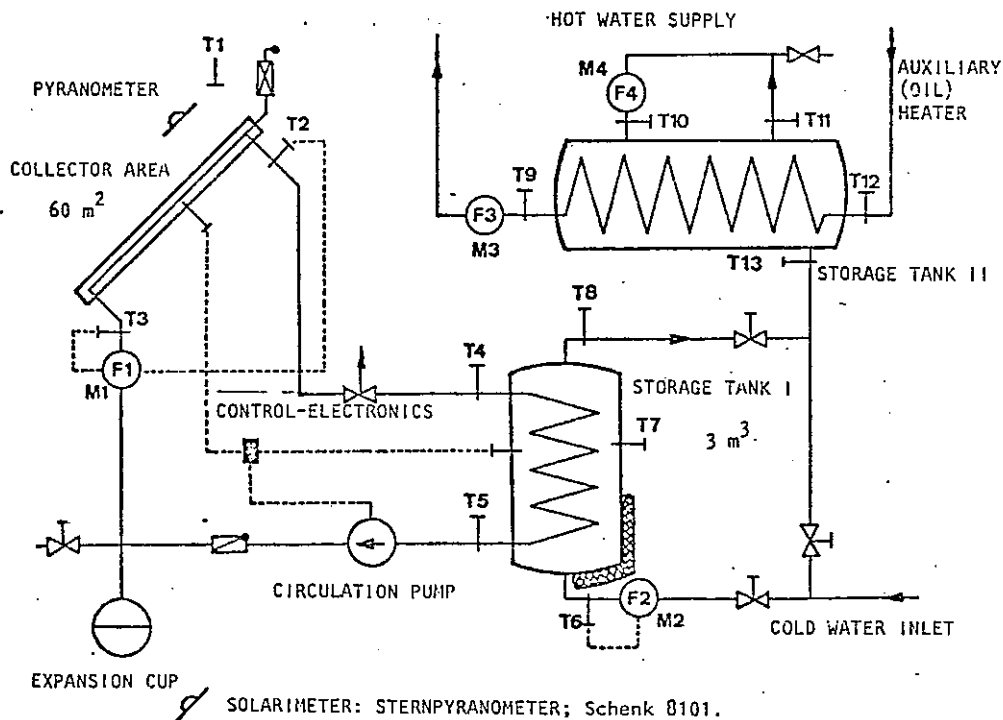

☞ SOLARIMETER: STERNPYRANOMETER; Schenk 8101.

⊙ FLOW METER: Schinzel ws-t-h-iv, MASS FLOW RATE.....M

⊥ TEMPERATURE SENSOR pt 100, Jumo 100 x 7 mm r 1/2",
Temperature.....T.

Directions for filling in the sheet is attached at the back.

FLAT PLATE SOLAR COLLECTORS RELIABILITY AND DURABILITY

DESCRIPTION OF SYSTEM, FLOW DIAGRAM, PICTURE OF COLLECTOR.

K03

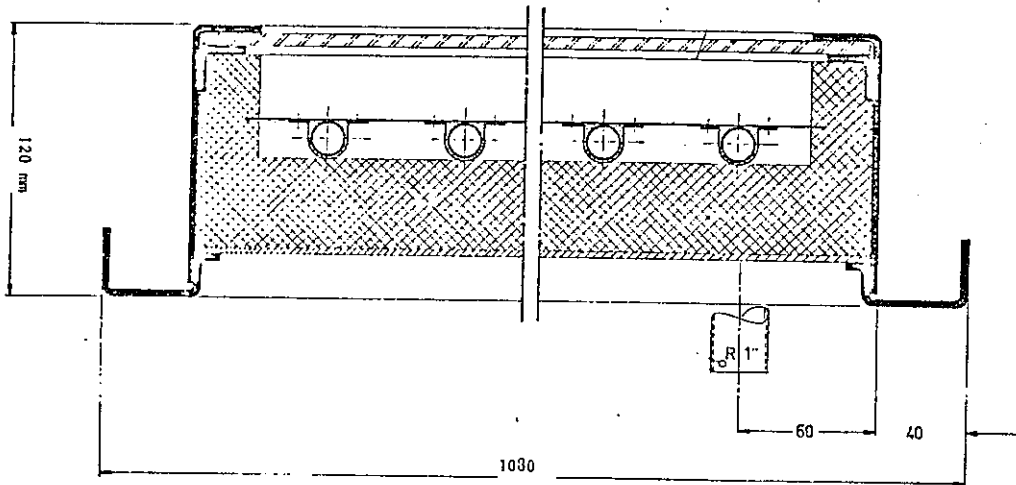

DESCRIPTION OF COLLECTOR.

APERTURE-AREA	1,88 m ²
MASS	16 kg
HEAT TRANSFER MEDIUM	0,9 l (Water Glycol)
MAX. PRESSURE	10 bar

FLAT PLATE SOLAR COLLECTORS RELIABILITY AND DURABILITY

3

COMPONENT DESCRIPTION (materials and manufacture procedure) :

Cover: Polycarbonat UV-stabilized, one layer

Absorber coating: black paint

Absorber: Copper

Insulation back: PU Foam 40 mm

Insulation sides: PU Foam

Collector enclosure

back and edges: Al Mg 3

Gaskets and sealants: Silicone, Rubber packing gasket

Flashing: Lead

Attachments: Angle irons etc.

Other details:

NUMBER THE FAILURES FOUND DURING THE INSPECTION:

1. Condensation on nine collectors
(mainly near the top).
2. Because of a nearby chimney there was a lot of dirt at the outside of the transparent covers.
The comparison of experimental results shows a reduction of efficiency in the range of 7 - 10%.
3. Grey-white patches on the absorber coating caused by drips of condensation.
4. Microcracks (UV-degradation) on most of the transparent covers.

FLAT PLATE SOLAR COLLECTORS
RELIABILITY AND DURABILITY

4

*REMARKS ON THE FAILURES.**Numbers refer to the list on page 3.**Description:**Potential cause:**How severe is the failure:**Possible remedy to avoid failures during production
and to mend it on the operating collector:*

ad 1: In the particular case the effect of natural washing by rain and snow is not sufficient to prevent considerable transmission losses. (Probably because of electrostatic forces that contribute to the adhesion of particular dirt to the cover). Periodical washing of the panels (four to six times a year) is therefore necessary.

FLAT PLATE SOLAR COLLECTORS, RELIABILITY AND DURABILITY X

Description of system, construction and failure of the solar collector discovered during examination.

Institute: Research Center, Sanyo Electric Co. Ltd

Author of report: K. Hinotani

Date and hour for inspection: 1, May 1980, at solar noon.

Location of system: Hirakata-shi, Osaka, Japan

Manufacturer of collector: Sanyo Electric Co. Ltd.

Installation contractor: Agency of Industrial Science and Technology,

Date of installation: March, ^{MITI} 1977

Type of system: Cooling, Heating and DHW supply.

Heat transfer media: Water

Safety system: Freeze protection: Pump in collector loop is automatically operated for freeze protection when water temperature in collector becomes below zero degree C.

Description of system, flow diagram:

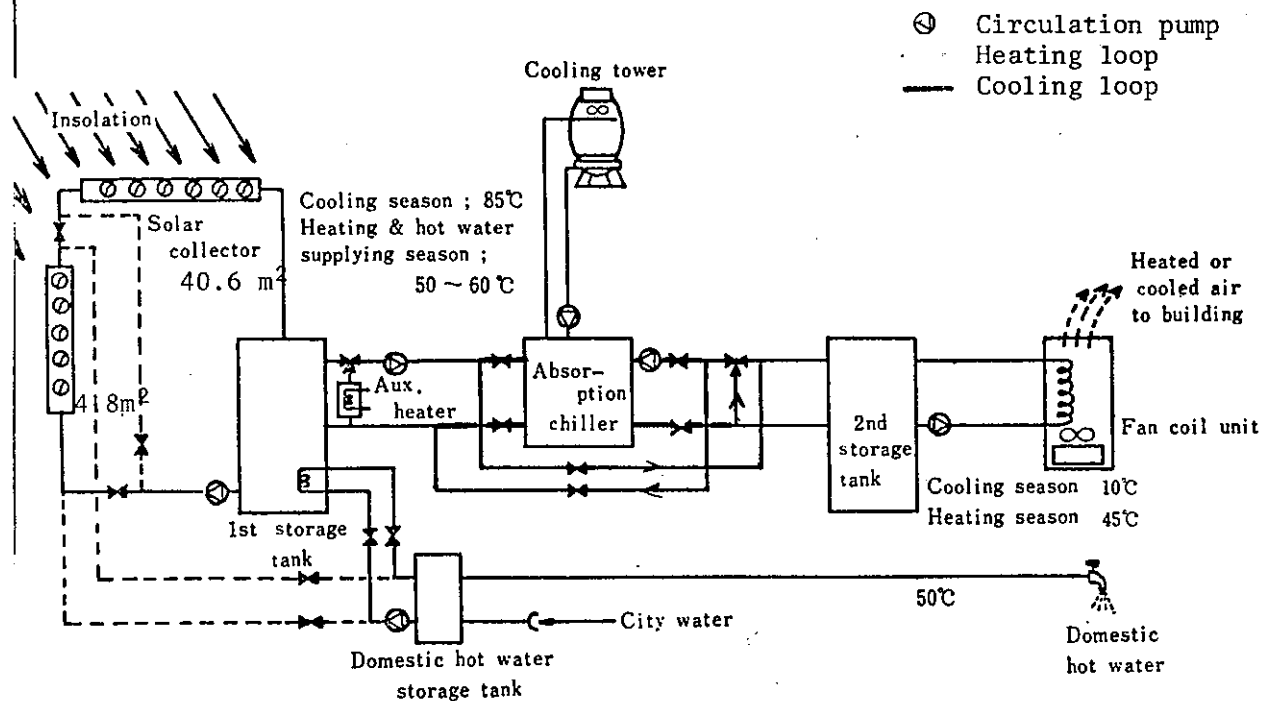

Directions for filling in the sheet is attached at the back.

Component description (materials and manufacturer procedure):

Cover: Glass Tube
 Absorber coating: Black Chrome
 Absorber: Copper plate, copper tube

Insulation back Evacuated

Insulation sides:

Collector enclosure
 back and edges:

Gaskets and sealants: Frit glass for sealant.

Flashing:

Attachments: Joint boxes

Other details: Collector tubes connected by U-shaped copper tubes with soldering.

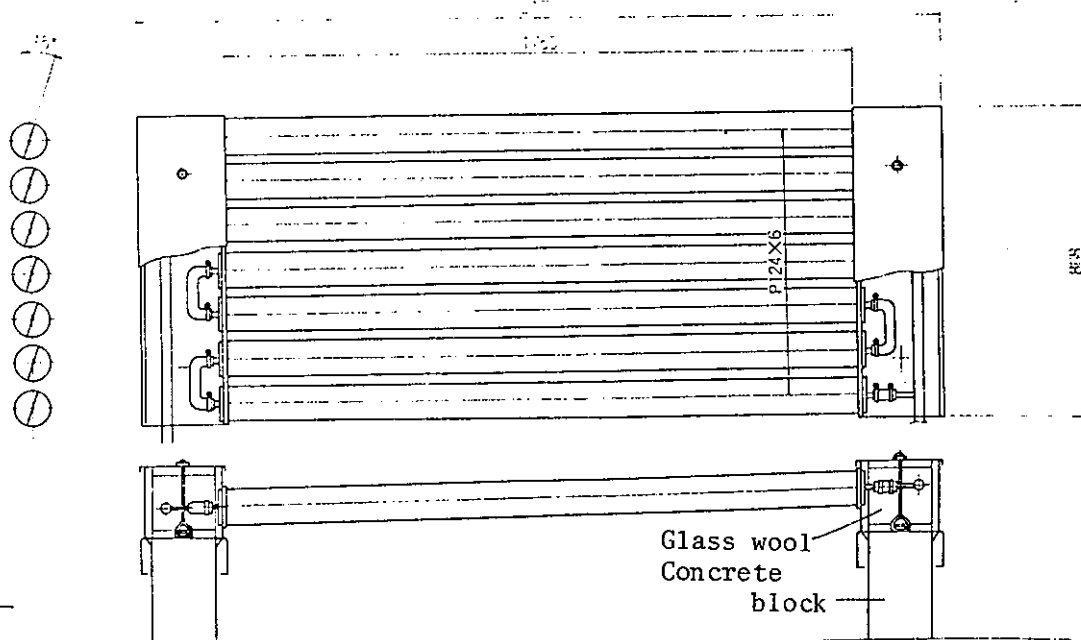
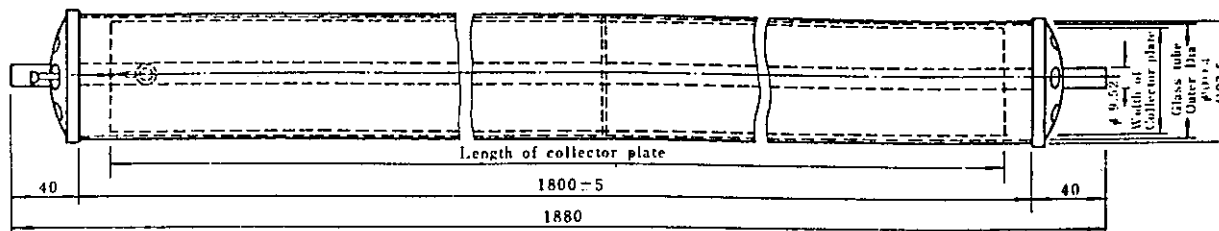
Description of collector:

Remarks

Number (see checklist)

Description:

Potential cause:

Possible remedy to avoid failure during production
and to mend it on the operating collector:

1. Dirt at the outside of the glass tube

Dirt is slightly accumulated on the outside of glass tube since there are tennis courts on the west side of the solar house. But the dirt is washed out when rain falls.

2. Slow leak

Slow leak occurred on the prototype of 1977 due to the way of sealing between the stem and copper tube (Fig. 2). Elongation in collector tube may be repeated and leak from the soldering part was found. The sealing portion is redesigned to prevent leak as shown in Fig. 3.

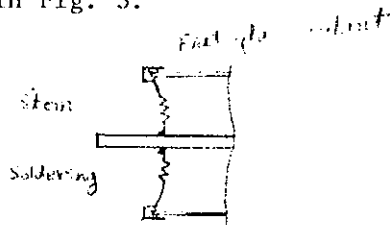

Fig. 2

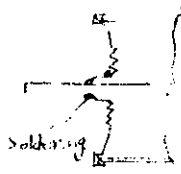

Fig. 3

3. Collector tube connection

Seven collector tubes were connected with U-shaped rubber tube to make a module of the prototype in 1977. Due to pressure rise in the collector tube when boiling happened to occur, leak from the connection was found. For the perfect leak protection, U-shaped copper tube instead of rubber tube were used for the connection to make the module.

4. Installation

The collector modules were installed with slope of 1/100 but stagnation of flow was observed in some of the modules. To prevent stagnation, the collector modules are now installed with 5 degree inclination facing south (Fig. 1)

FLAT PLATE SOLAR COLLECTOR, RELIABILITY AND DURABILITY

資料 6

Checklist to be used when examining solar collectors*

Failure Detail	Con-densa-tion	Dirt or deposite	discolo-ration	Corro-sion	Outgas-sing	Flak-ing	Crack-ing	Warp-page	Leak-age	Break-age	Other degene-ration
Covers	NF	1	NF	NA	NA	NF	NF	NF	2**	NF	NF
Absorber coating	NF	NA	NF	NA	NF	NF	NF	NF	NA	NA	NF
Absorber	NF	NA	NF	NF	NF	NF	NF	NF	NA	NA	NF
Insulation	NF	NA	NF	NF	NF	NA	NA	NA	NA	NA	NF
Enclosure	NF	NA	NF	NF	NA	NF	NF	NA	NA	NF	NF
Flashing	NA										
Gasket	NA										
Sealants	NA	NF	NF	NA	NA	NF	NF	NA	NF	NA	NF
Attachments	NF	NF	NF	NA	NA	NA	NF	NA	NA	NA	NF
Heat transfer media	NA	NA	NC	NA	NA	NA	NA	NA	NA	NA	NF
Remaining details									3**		
									4**		

*Number remarks for failure. Fill in NF for no failure, NA for not applicable and NC for not checked.
 ** No failure at the time of the diagnosis, but happened in the past and improved.

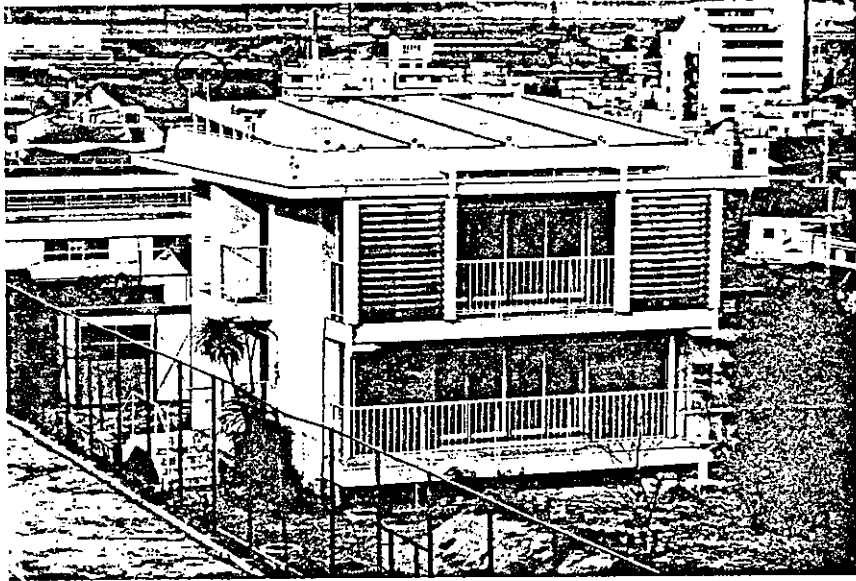

Fig. 1

Investigation of common problems, failures and changes
in the collectors

Diagrams for 7 vital parts of the inspected solar collectors are presented. Here is shown which collectors had the same combination of category of problems, failures and changes of the collector, and influence from climate parameters and surroundings.

OBSERVED PROBLEMS, FAILURES AND CHANGES OF SOLAR COLLECTORSTHE COVER

The solar In- collector fluence from surroundings and climate		Collector construc- tion	Collector materials used	Quality of pro- duction	Installa- tion pi- ping sy- stem	Mainte- nance	Opera- tion	Influence from cli- mate alone
		1	2	3	4	5	6	7
Stagna- tion, high temp.	1	C,D,H, Z,K,B	A,E,H, J,J(L), H				L(L)	
Moistu- re, water in col- lector	2	A,D,E,H, I,J,K,K, P,O,S,Tl, U,Z,V,N (Condensation)						
Other clima- te para- meters	3		D(L),E(L) V(L)					O(L) I(L) H(L) J(L) A(L) F(L) K(L) V(L)
Repair, mainte- nance	4							Tl(L)T2- S(L) Z(L) (dirt)
Influ- ence from the col- lector alone	5			E,K(L)				
Comments	Condensation, dirt and outgassing on covers are very often seen. Other problems are bulging of covers, ageing of cover and pro- duction quality.							

Table 3.1

Observed problems, failures and changes are listed for different parts of the solar collector. From the table it is seen how often observed problems, failures or changes are a result of respectively the solar collector and/or different climate parameters. (L) indicates long term effects.

OBSERVED PROBLEMS, FAILURES AND CHANGES OF SOLAR COLLECTORS

COVER/ENCLOSURE ASSEMBLY AND GASKETS AND SEALANTS:

The solar In-collector influence from surroundings and climate		Collector construction	Collector materials used	Quality of production	Installation piping system	Maintenance	Operation	Influence from climate alone
		1	2	3	4	5	6	7
Stagnation, high temp.	1	A(L), N T1, 2(L)						
Moisture, water in collector	2	D(L), B	O					
Other climate parameters	3		I(L)					
Repair, maintenance	4							
Influence from the collector alone	5							
Comments	Leakage through the cover/enclosure assembly is an important problem. The reason might be thermal stresses, ageing, bad quality or wrong materials for sealants and gaskets. There are consequences for other parts of collector resulting from this problem.							

Table 3.2

Observed problems, failures and changes are listed for different parts of the solar collector. From the table it is seen how often observed problems, failures or changes are a result of respectively the solar collector and/or different climate parameters. (L) indicates long term effects.

OBSERVED PROBLEMS, FAILURES AND CHANGES OF SOLAR COLLECTORS

THE ABSORBER

The solar influence from surroundings and climate		Collector construction	Collector materials used	Quality of production	Installation piping system	Maintenance	Operation	Influence from climate alone
		1	2	3	4	5	6	7
Stagnation, high temp.	1	F	I					
Moisture, water in collector	2	F(L) G(L) V(L) Z(L)	C(L) B(L) P(L) N(L) U(L) R(L)	D(L) B(L) N(L) R(L) P(L) U(L)				
Other climate parameters	3	S(L) K(L) D(L) (dust, dirt)						
Repair, maintenance	4			U				
Influence from the collector alone	5		Q, P(L)	G, T2, O(L)				
Comments	Warpage and corrosion is a serious problem for the absorber. Failures in construction and choice of material for other parts of the collector are often the reason for degradation of the absorber. The quality of the absorber surface is therefore important.							

Table 3.3

Observed problems, failures and changes are listed for different parts of the solar collector. From the table it is seen how often observed problems, failures or changes are a result of respectively the solar collector and/or different climate parameters. (L) indicates long term effects.

OBSERVED PROBLEMS, FAILURES AND CHANGES OF SOLAR COLLECTORS

INSULATION OF THE COLLECTOR

The solar In- collector influence from surroundings and climate	Collector construction	Collector materials used	Quality of production	Installation piping system	Maintenance	Operation	Influence from climate alone
	1	2	3	4	5	6	7
Stagnation, high temp.	1	N, P T1					
Moisture, water in collector	2	R					
Other climate parameters	3						
Repair, maintenance	4						
Influence from the collector alone	5	E, E					
Comments	Insulation is difficult to report in inspection reports because often you can't see it. Side insulation sometimes loosens. Polymer foam often expands and burns at high temperatures.						

Table 3.4

Observed problems, failures and changes are listed for different parts of the solar collector. From the table it is seen how often observed problems, failures or changes are a result of respectively the solar collector and/or different climate parameters. (L) indicates long term effects.

OBSERVED PROBLEMS, FAILURES AND CHANGES OF SOLAR COLLECTORSTHE ENCLOSURE

The solar In-collector influence from surroundings and climate	Collector construction	Collector materials used	Quality of production	Installation piping system	Maintenance	Operation	Influence from climate alone
	1	2	3	4	5	6	7
Stagnation, high temp.	1	T1	N				
Moisture, water in collector	2	B(L), B(L) C(L), F(L) I(L)	G	L(L)			
Other climate parameters	3	L(L)					
Repair, maintenance	4						
Influence from the collector alone	5	E					
Comments	Expansion of enclosure might be a result of the influence of high temperatures on insulation, absorber or cover. Galvanic corrosion can be a problem. The glass fillet in the bottom of the collector and the pipeholes in the enclosure often lead to leakage.						

Table 3.5

Observed problems, failures and changes are listed for different parts of the solar collector. From the table it is seen how often observed problems, failures or changes are a result of respectively the solar collector and/or different climate parameters. (L) indicates long term effects.

OBSERVED PROBLEMS, FAILURES AND CHANGES OF SOLAR COLLECTORSCONNECTIONS AND PIPING

The solar In-collector influence from surroundings and climate		Collector construction	Collector materials used	Quality of production	Installation piping system	Maintenance	Operation	Influence from climate alone
		1	2	3	4	5	6	7
Stagnation, high temp.	1						Q	
Moisture, water in collector	2			H,S	C(L),L(L) T1(L) T2(L)			
Other climate parameters	3		R(L)				R	
Repair, maintenance	4							
Influence from the collector alone	5				C			
Comments		Bad quality of piping and insulation of piping is often a problem. It often results in corrosion. The connections between collectors are often difficult to make durable.						

Table 3.6

Observed problems, failures and changes are listed for different parts of the solar collector. From the table it is seen how often observed problems, failures or changes are a result of respectively the solar collector and/or different climate parameters. (L) indicates long term effects.

OBSERVED PROBLEMS, FAILURES AND CHANGES OF SOLAR COLLECTORS

THE FLASHING

The solar In-collec- tor fluence from surround- ings and climate	Collector construc- tion	Collector materials used	Quality of pro- duction	Installa- tion pi- ping sy- stem	Mainte- nance	Opera- tion	Influence from cli- mate alone
	1	2	3	4	5	6	7
Stagna- tion, high temp.	1						
Moistu- re, water in col- lector	2	S,J					
Other clima- te para- meters	3						
Repair, mainte- nance	4	J					
Influ- ence from the col- lector alone	5	Z(L)	S				
Comments	The flashing is supposed to make the collector construction raintight. This is often a problem because of chosen materials, failures in construction or failures at the installation.						

Table 3.7

Observed problems, failures and changes are listed for different parts of the solar collector. From the table it is seen how often observed problems, failures or changes are a result of respectively the solar collector and/or different climate parameters. (L) indicates long term effects.

OBSERVED PROBLEMS, FAILURES AND CHANGES OF SOLAR COLLECTORSCOMMENTS ON EFFICIENCY

The solar In- collector fluence from surroundings and climate	Collector construc- tion	Collector materials used	Quality of pro- duction	Install- ation pi- ping sy- stem	Mainte- nance	Opera- tion	Influence from cli- mate alone
	1	2	3	4	5	6	7
Stagna- tion, high temp.	1						
Moistu- re, water in col- lector	2						
Other clima- te para- meters	3						R(L)
Repair, mainte- nance	4						
Influ- ence from the col- lector alone	5	J,J					
Comments	Efficiency is very often influenced by changes of collector durability, but it can be difficult to measure. Here is reported changes of τ because of dirt, and too thin insulation and too small cover spacing which has influence on efficiency.						

Table 3.8

Observed problems, failures and changes are listed for different parts of the solar collector. From the table it is seen how often observed problems, failures or changes are a result of respectively the solar collector and/or different climate parameters. (L) indicates long term effects.

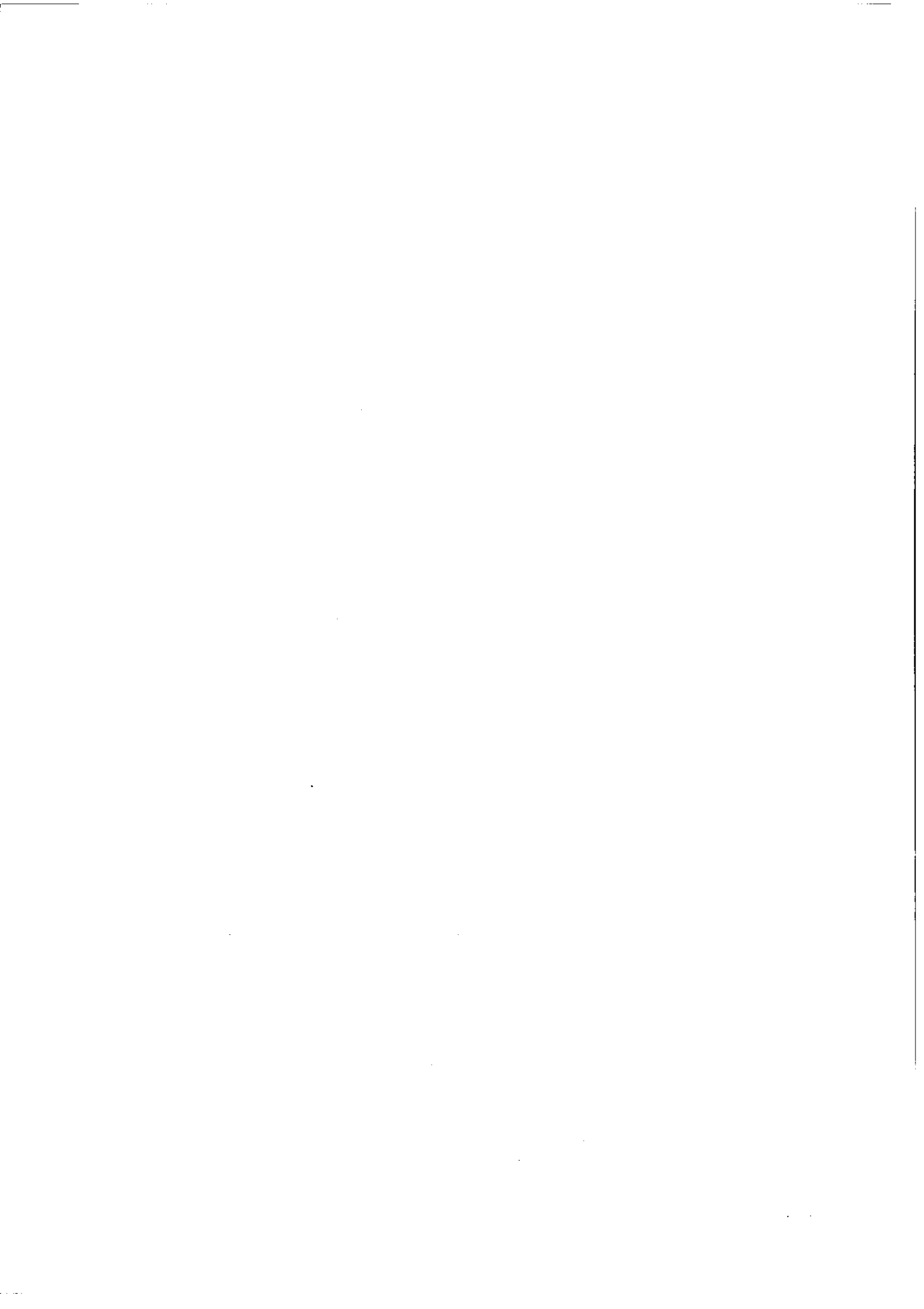



IEA
SOLAR R&D

INTERNATIONAL ENERGY AGENCY

**program
to develop and test
solar heating
and cooling systems**

Inspection report

**Reliability and durability of
flat plate solar collectors**

name and address of installation

author of report

institute

FLAT PLATE SOLAR COLLECTORS RELIABILITY AND DURABILITY

HOW TO USE THIS INSPECTION FORMAT

This inspection format is designed to allow useful information to be gathered on good design features of solar collectors, and their problems and failures in operating solar heating systems.

The format includes several pages requesting general information of the inspected collector and the solar system in which it is working. It is important to give detailed information of the collector construction, the materials used, and the installation. Information on surface treatment, sealing materials and gaskets is of special interest in order to help identify good design features.

Small drawings and photographs of items such as the cover and the enclosure assembly, the flashing system, the pipework & connections, etc. would also be of help in evaluating collector construction. A blank sheet is included on the last page, which may be photocopied and used for extending particular sections of the inspection report.

Before the inspection it may be helpful to study the checklists on pages 5, 6 & 8. These have been drawn up from previous collector inspection experience and analysis, and most previous problems and failures have been included. The questions on page 4 should also be studied before the inspection.

Problems and failures observed at the inspection should be referred to using the notation shown in the checklist on pages 5 & 6. More than one inspection of a solar collector installation should be made by using page 5 to 9 several times. Only changes from the first inspection should be reported at later inspections and should be identified by using the new inspection date, which is also supposed to be written on page 1.

Following the inspection, pages 7 & 9 should be used to more fully describe the problems, failures and good design features. Here one should also try to identify potential causes and possible remedies in production and installation.

It is important to record any part of the collector where no problems or failures were observed. A description of the successful details, and an explanation of why there were no problems, would be helpful and provide information for subsequent recommendations and design & installation guides.

These inspection reports will be ultimately used to produce reports on collector reliability and durability, and provide information on the positive aspects of collector design, manufacture and installation.

This format has been jointly designed by the I.E.A. and the C.E.C., and may therefore be used when reporting to either or both groups. The appropriate group cover should be used for identification.

FLAT PLATE SOLAR COLLECTORS 1

RELIABILITY AND DURABILITY

Name & address of installation:

Author of report:

Institute:

Date & time of inspection:

DESCRIPTION OF THE SOLAR SYSTEM

Description of location:
(e.g. rural area, heavy industrial area,
near a sea coast, near chemical works, etc.).

Type of system:
(water heating,
space heating, etc.)

Collector type used:
(modules on roof, integrated modules
or site-built collector)

Manufacturer of collector:

Installation contractor:

Date of installation:

Is there a guarantee for the
reliability of the collector ?:

Total panel area & number of collectors:

Orientation & tilt of collectors:

Heat transfer medium, additives, flow rate:

Safety system:
(including freezing & boiling protection)

Maximum pressure allowed in collector:

FLAT PLATE SOLAR COLLECTORS RELIABILITY AND DURABILITY

DESCRIPTION OF THE SYSTEM

SYSTEM FLOW DIAGRAM:

SHORT EXPLANATION OF SYSTEM OPERATING MODES:

FLAT PLATE SOLAR COLLECTORS RELIABILITY AND DURABILITY

DESCRIPTION OF THE SOLAR COLLECTOR

DIAGRAM OF COLLECTOR (including cross sectional view & dimensions)

PHOTOGRAPHS OF COLLECTOR ARRAY

FLAT PLATE SOLAR COLLECTORS RELIABILITY AND DURABILITY

4

Materials and manufacturing processes used for the collector

Cover, material & thickness:

Cover, method of sealing,
sealants and gaskets used:

Absorber, materials and dimensions of
plate & tubes, fabrication method:

Absorber Coating:
(details if possible)

Insulation back, materials & thickness:

Insulation sides, material & thickness:

Collector enclosure, materials:
of back and edges:

Collector enclosure, method of
assembly and sealants used:

Installation of the collector

Method of collector attachment to roof:

Method of sealing (flashing)
collector into roof, material used:

Method of sealing (flashing)
between collectors, materials used:

Pipework between collectors,
materials, connections, insulation used:

Pipework to storage, materials,
connections, insulation used:

Operation of the system

Have there been any problems with the
system controller?, f.i. placing of sensors ?:

Have there been any
problems with the pump ?:

Has the system suffered from air locks ?:

If there have been any interruptions
in the operating of the system, have
these affected the collectors ?:

Was the collector stagnation protected
during construction ?:

Have the collectors ever been repaired
and is there any plans for modification
or repair in the near future ?:

FLAT PLATE SOLAR COLLECTORS RELIABILITY AND DURABILITY

5

CHECKLIST

PROBLEMS & FAILURES FOUND DURING THE COLLECTOR INSPECTION

To investigate this please use the following checklist. Problems & failures known from experience and previous collector inspections have been listed as a guide.

OBSERVED, NOT OBSERVED and NOT POSSIBLE TO INSPECT should be referred to by V, X and /, respectively. The number of collectors in the array which suffer from any given problem or failure should be indicated in the frequency column of the checklist.

Reference number	Problems & Failures of the collector	Observed: V Not observed: X Not inspected: /	Frequency
<u>1.</u>	<u>Cover</u>		
1.1	Condensation on the inside of the cover		
1.2	Outgassing, deposits inside the cover		
1.3	Dirt on cover surface		
1.4	Ageing (discolouration, cracking, etc.)		
1.5	Breakage or collapse of cover		
1.6	Sagging of cover		
1.7	Others (specify)		
<u>2.</u>	<u>Absorber</u>		
2.1	Dirt or dust on absorber		
2.2	Corrosion on absorber surface		
2.3	Peeling & flaking of absorber surface		
2.4	Leakage of absorber		
2.5	Deformation of absorber		
2.6	Deposits or condensation drops on abs.		
2.7 etc.	Others (specify)		
<u>3</u>	<u>Cover enclosure assembly (sealants & gaskets)</u>		
3.1	Cover loose or slipped from enclosure		
3.2	Assembly is leaking		
3.3	Degradation of sealants		
3.4 etc.	Others (specify)		

FLAT PLATE SOLAR COLLECTORS RELIABILITY AND DURABILITY

6

Reference number	Problems & Failures of the collector	Observed: <input type="checkbox"/> V Not observed: <input type="checkbox"/> X Not inspected: /	Frequency
<u>4.</u>	<u>The Insulation</u>		
4.1	Degradation or expansion of insulation		
4.2	Water in the insulation		
4.3 etc.	Others (specify)		
<u>5.</u>	<u>Enclosure</u>		
5.1	Rain leakage other than through cover seals		
5.2	Corrosion of the enclosure & fastenings		
5.3 etc.	Others (specify)		
<u>6.</u>	<u>Mounting of collector</u>		
6.1	Leaks into house		
6.2	Rotten timber		
6.3	Failure of collector mountings		
6.4	Leakage of flashing		
6.5 etc.	Others (specify)		
<u>7.</u>	<u>Connections and piping</u>		
7.1	Leaking pipes or pipe connections		
7.2	Poor pipe insulation		
7.3	Problems with thermal expansion		
7.4	Bad soldering or welding		
7.5	Problems with flow distribution (airlocks, etc.)		
7.6 etc.	Others (specify)		
<u>8.</u>	<u>Other components</u>		
8.1 etc.			

When problems or failures are observed at the inspection, a detailed description and evaluation should be given on page 7.

When no problems or failures are observed for particular components, then a detailed description & evaluation of the good design features should be given on page 9.

FLAT PLATE SOLAR COLLECTORS RELIABILITY AND DURABILITY

7

Comments on the problems and failures of the collector

Discuss causes & severity of each problem or failure using the Reference Number from the checklist. Suggest how such problems & failures might be avoided in future and how the existing collectors might be repaired. Please indicate if you think that any of the failures might have been predicted by using either (a) materials tests, or (b) durability tests of a collector module.

FLAT PLATE SOLAR COLLECTORS RELIABILITY AND DURABILITY

8

CHECKLIST OF DESIGN FEATURES

YES/NO

A. Condensation and Ventilation

Does the collector have ventilation holes ?:

Has condensation been prevented by suitable ventilation ?:

Does the collector enclosure have drain holes ? :

B. Weather protection

Does the cover & enclosure allow rain & snow to run off easily ?:

Does the cover satisfactorily withstand high wind loads, hail, rain, etc. ?:

Are the mountings adequate to withstand high wind loads ?:

Are all components protected adequately against weather & corrosion ?:

C. Internal protection

Does the absorber have a durable absorber surface ?:

Are the cover & absorber protected from insulation outgassing ?:

Will the insulation materials be able to withstand the expected stagnation temperatures ?:

Does the system employ internal corrosion protection ?:

Are special provisions made for air venting ?:

D. General construction

Does the design include provision for thermal expansion ?:

Has the collector been generally well designed & constructed ?:

Has the collector been properly installed and is it easy to maintain and repair ?:

Are all materials and components suitable ?:

E. Performance

Is the collector operating satisfactorily ?:

Is the system reliable ?:

Is the collector performance affected by observed problems and failures ?:

Is a satisfactory service life expected ?:

Expected lifetime from the date of installation (please indicate below):

Less than 3 years: 3 - 5 years: 5 - 10 years: 10 - 15 years: 15 - 20 years: More than 20 years:

Detailed description and evaluation of good design features should be given on page 9.

FLAT PLATE SOLAR COLLECTORS RELIABILITY AND DURABILITY

9

Detailed description and evaluation of the good design features

Please discuss and describe all good design features in conjunction with the Checklists on pages 5, 6 & 8.

FLAT PLATE SOLAR COLLECTORS
RELIABILITY AND DURABILITY

Examples of recommendations for solar collector construction

Fig. 1 and fig. 2 are examples of recommendations for respectively cover/enclosure assembly for solar collectors and installation of solar collectors, either as modules built into the roof or as site-built solar collectors.

You can find these figures in a report on longtime durability of solar collectors, which has been made under the Danish Solar Heating Programme, (in Danish). In this report experts in different areas have contributed with articles giving recommendations for solar collector construction based on known experiences at that time. Surface treatment of absorbers is also covered in this report.

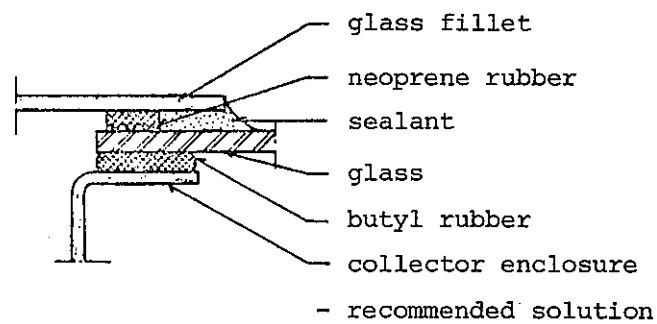
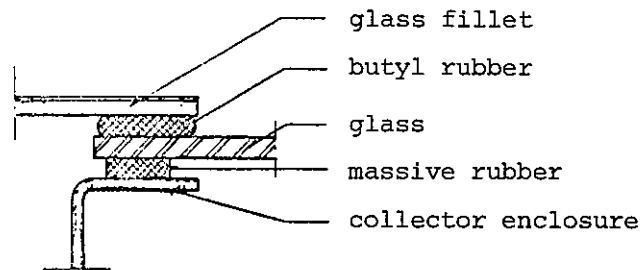
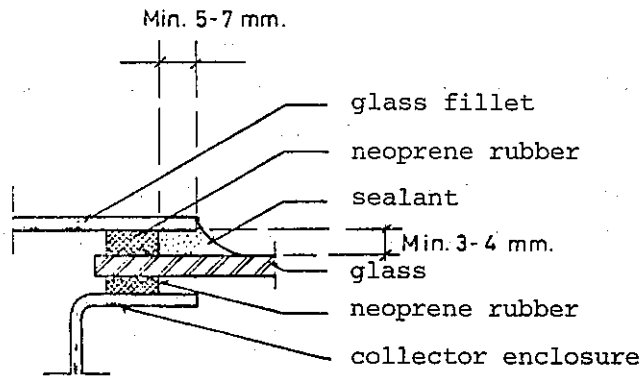
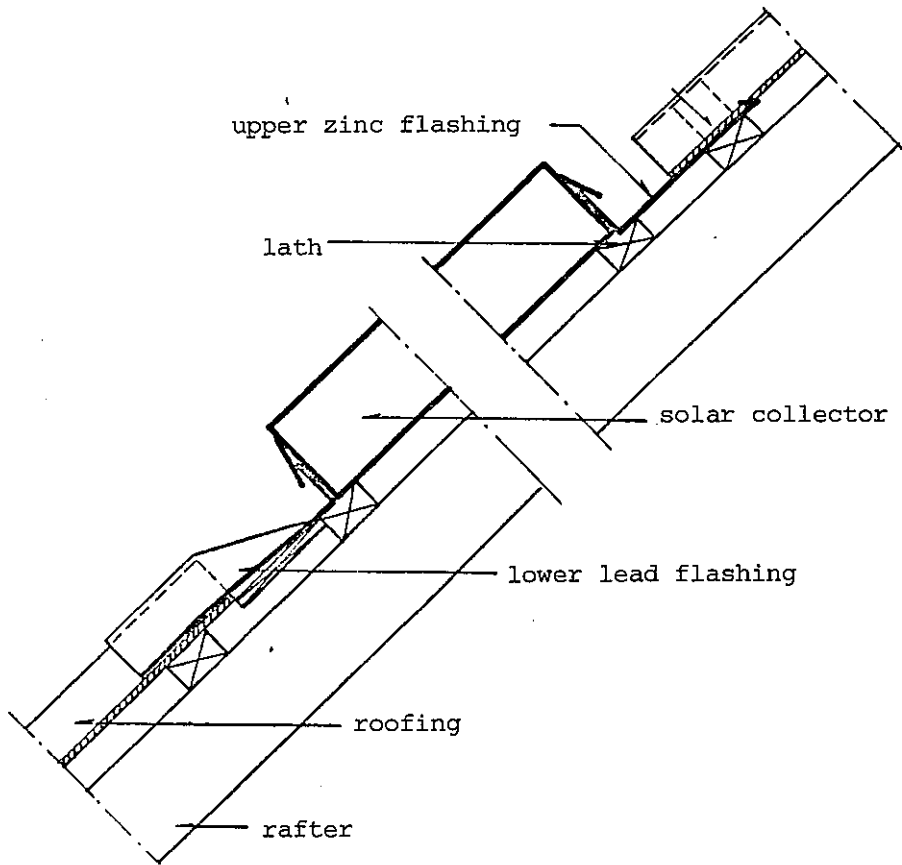
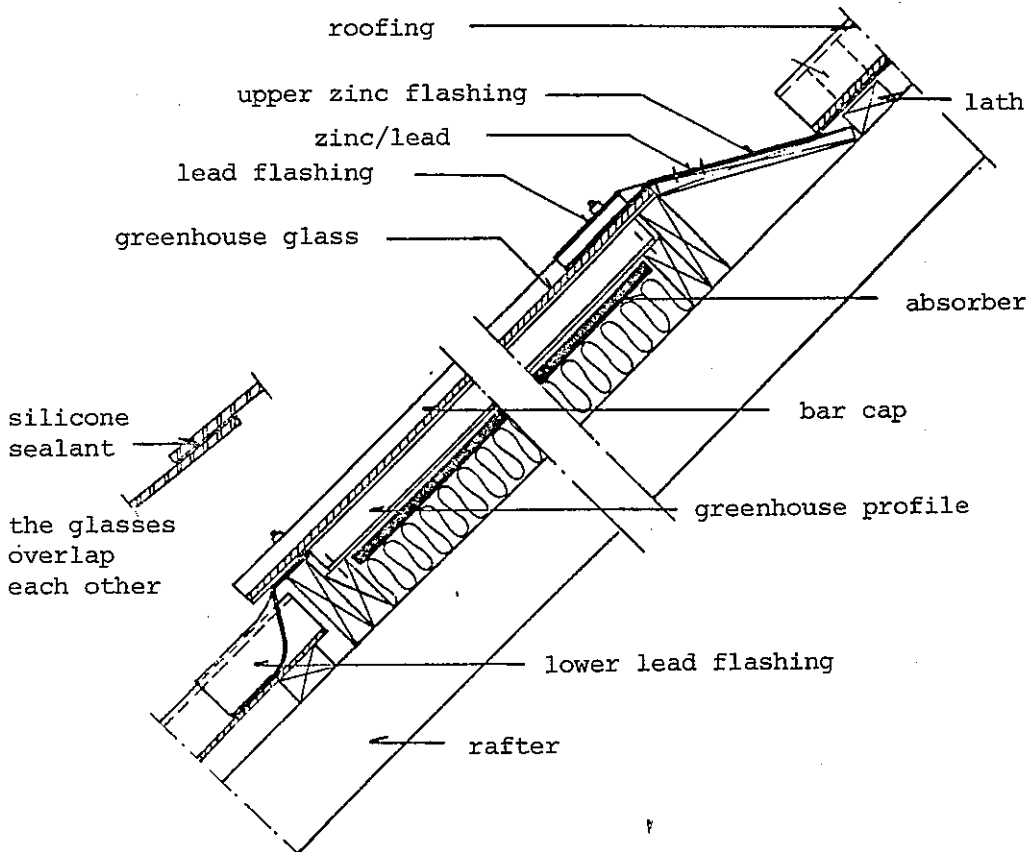

Fig. 1. Recommendations for cover/enclosure assembly - three solutions.



Solar collector built into the roof



Site-built solar collector with a greenhouse type of glass cover

Fig. 2. Recommendations for installation of solar collectors.

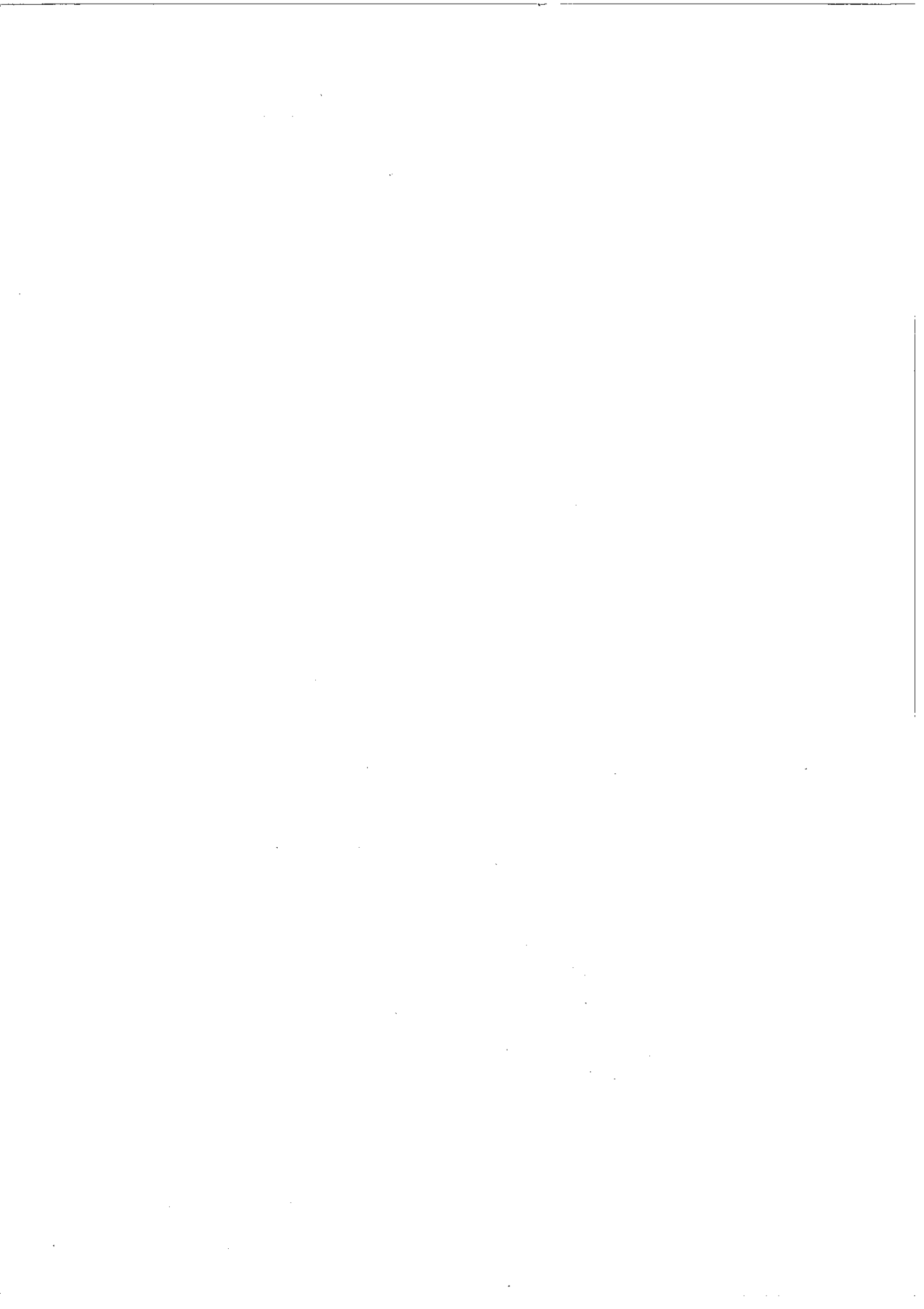

IEA SOLAR HEATING AND COOLING PROGRAMME

Task III Members Performance Testing of Solar Collectors

OPERATING AGENT

GERMANY	Dr. H. D. Talarek Solar Energy Branch / IKP Kernforschungsanlage Jülich Postfach 1913 D-5170 Jülich/ Germany	Tel. 02461/61-4640 Telex: 833 556 kfa d
---------	--	--

RESPONSIBLE RESEARCHERS

AUSTRALIA	D. Proctor CSIRO Division of Mechanical Engineering P.O.B. 26 Highett, Victoria 3190 Australia	
AUSTRIA	Dr. Manfred Bruck Austrian Solar and Space Agency Garnisongasse 7 A-1090 Vienna/Austria	Tel. 0222/438177 Telex: 76560 assa a
BELGIUM	Prof. André Pilatte Faculté Polytechnique de Mons 31, Blvd. Dolez B-7000 Mons/Belgium	Tel. 065/338191
DENMARK	Mr. Svend Svendsen Thermal Insulation Lab. Building 118 Technical University of Denmark DK-2800 Lyngby/Denmark	Tel. 02/883511 Telex: 37529 dthdia dk
	Mr. Peder Vejsig Pedersen Thermal Insulation Lab. Building 118 Technical University of Denmark DK-2800 Lyngby/Denmark	Tel. 02/883511 Telex: 37529 dthdia dk
	Mr. Pauli Andersen Technological Institute Department of Surface Treatment DK-2630 Tastrup/Denmark	
CANADA	Mr. S. J. Harrison National Research Council Canada Division of Building Research Energy & Services Section Ottawa/Ontario K1A 0R6 Canada	Tel. 613 993-1421

EUROPEAN COM- MISSION	Dr. E. Aranovitch European Commission Joint Research Centre Euratom I-21020 Ispra/Italy	Tel. 780131 (0332) Telex: 38042 euratom
GERMANY	Mr. H. J. Daum Industrieanlagen-Betriebs- gesellschaft mbH Einsteinstr. D-8012 Ottobrunn/Germany	Tel. 089/60081 Telex: 0524001
	Dr. Boxhammer W.C. Heraeus GmbH Postfach 1553 D-6450 Hanau/Germany	Tel. 06181/360409 Telex: 415 202 16 hud/-12
	W. Schölkopf Sektion Physik Universität München Amalienstr. 54/IV D-8000 München 40/Germany	Tel. 089/2180-3443
	Dr. H. J. Stein Solar Energy Branch / IKP Kernforschungsanlage Jülich GmbH Postfach 1913 D-5170 Jülich/Germany	Tel. 02461-616067 Telex: 833 556 kfa d
	Mr. H. Wenzel TÜV Bayern e.V. Direktionsbereich 2 Rüdesheimer Str. 21 Postfach 410 420 D-8000 München 21/Germany	Tel. 089/5791-330
GREECE	Prof. P. Yianoulis Faculty of Physics II University of Patras Patras/Greece	Tel. 061/429712-13
ITALY	Prof. Nunzio Antonio Mancini Istituto di Fisica Universita di Catania Corso Italia 57 Catania/Italy	
JAPAN	Dr. Sakae Tanemura Solar Research Laboratory The Government Industrial Research Institute, Nagoya 1, Chome, Hiratemachi Kita-Ku Nagoya 462/Japan	Tel. 0081-(052) 911-2111 Ext. 432 Telex: J22916 (eidmiti)

NETHERLANDS	Ir. C. den Ouden Technisch Physische Dienst TNO-TH P.O.Box 155 Delft/Netherlands	Tel. 015/569 300 Telex: 31615 nl
	Mr. A. J. T. M. Wijsman Technisch Physische Dienst TNO-TH P.O.Box 155 Delft/Netherlands	Tel. 015/569 300 Telex: 31615 nl
NEW ZEALAND	Dr. R. F. Benseman Physics and Engineering Lab. Dept. of Scientific and Industrial Research Private Bag Lower Hutt/New Zealand	Tel. 301/921-2640 Telex: 3814 physics nz
SPAIN	Dr. Ing. Eduardo Mezquida Instituto Nacional de Tecnica Aerospecial Torejon de Ardoz Madrid/Spain	Tel. 6750700
SWEDEN	Dr. Hans E. B. Andersson Statens Provningsanstalt Box 857 S-50115 Boras/Sweden	Tel. 033/102000/228 Telex: 36252
	Mr. H. Wennerholm Statens Provningsanstalt Box 857 S-50115 Boras/Sweden	Tel. 033/102000/228 Telex: 36252
SWITZERLAND	Dr. P. Ambrosetti Eidg.Inst.f.Reaktorforschung CH-5303 Würenlingen/Switzerland	Tel. 056/981741 Telex: 53714 eir ch
	H. U. Frei HTL Rapperswil Ingenieurschule CH- Rapperswil	
	Dr. J. Keller Eidg.Inst.f.Reaktorforschung CH-5303 Würenlingen/Switzerland	Tel. 056/981741 Telex: 53714 eir ch
	Dr. J. M. Suter Eidg.Inst.f.Reaktorforschung CH-5303 Würenlingen/Switzerland	Tel. 056/981741 Telex: 53714 eir ch
UNITED KINGDOM	Dr. W. B. Gillett Solar Energy Unit University College Newport Road Cardiff CF2 ITA/UNITED KINGDOM	Tel. 0044-211-7041 Telex: 49635

U.S.A.

Mr. B. Dokos
DSET Laboratories, Inc.
Box 1850, Black Canyon Stage
Phoenix, Arizona 85029
USA

Tel. 602-465-7356
Telex: 910-950-4681 dset
phx

Dr. Kent Reed
National Bureau of Standards
Building 226
Room B104
Washington D.C. 20234/U.S.A.

Tel. 301/921-3637

This report contains a compilation and evaluation of 25 inspection reports on reliability and durability of solar collectors in existing solar energy systems. The reports are made by participants of the IEA Solar Heating and Cooling Programme, Task III, according to a format developed for this purpose.

Different kinds of problems, changes and failures have been observed for all the inspected solar collectors.

A presentation of the above with respect to collector part, problem area and influence from climate and surroundings is made.

This report is part of the work of the

IEA Program to Develop and Test
 Solar Heating and Cooling Systems
Task III: Performance Testing of Solar
 Collectors
Subtask b: Development of Test Procedures for
 Reliability and Durability

Distribution: Unrestricted
Additional Copies can be ordered from:

Thermal Insulation Laboratory
Technical University of Denmark
Building 118
DK-2800 Lyngby, Denmark

Price: 60 Dkr.